

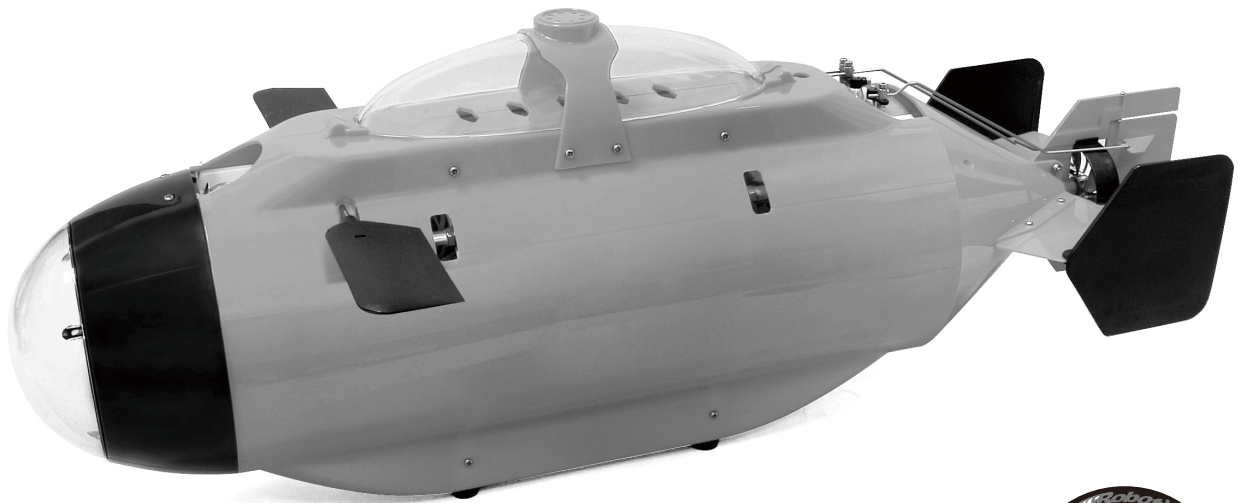

T T R - S B S E A W O L F



No.5222-F

⚠ Please read all instructions thoroughly before assembling the kit. ⚠

⚠ For fresh water use only. ⚠

⚠ The contents are subject to change without prior notice due to product improvements and specification changes.

INSTRUCTION MANUAL

WARRANTY

Thunder Tiger Corporation guarantees this model kit to be free from defects in both material and workmanship. The total monetary value under warranty will in no case exceed the cost of the original kit purchased. This warranty does not cover any components damaged by use or modification. Part or parts missing from this model must be reported within 60 days of purchase. No part or parts will be sent under warranty without proof of purchase. To receive part or parts under warranty, the service center must receive a proof of purchase and/or the defective part or parts. Should you find a defective or missing part, contact the authorized Thunder Tiger Service/Distributor nearest you. Under no circumstances can a dealer or distributor accept return if assembly has started.

INTRODUCTION

Thank you for your purchase of the TTR Seawolf submarine. The Seawolf submarine is the 1st underwater R/C model by TTR. Equipped with high technology operating system in the inner hull tube, covered by bright orange color outer hull, the Seawolf will let you enjoy the underwater world.

With static diving system, operating the Seawolf submarine is just like the real thing. The system equip with a ballast tank that comes with a pump unit. Start the pump to induct the water into the ballast tank. Control the amount of water into the ballast tank, the Seawolf submarine can dive from the surface and stay underwater in static. Using the propulsion power unit and full elevator and rudder control, you can drive the Seawolf submarine gracefully into water. Install a digital camera and you can watch the amazing underwater scenes.

Equipped with an auto protecting system, if the system detects low battery power, low transmission signal or leakage, the pump will start automatically to flood the water out of the ballast tank to make the Seawolf submarine float back to the surface.

TTRobotix Seawolf submarine will take you to enjoy the mystery world under the water!

INDEX

INTRODUCTION	01
ITEMS & TOOLS REQUIREMENT	02
IMPORTANT NOTES & WARNING	02
CONFIGURATION	03
RADIO CONTROL vs SUBMARINE MOVEMENT	04
INTRODUCTION FOR THE MAIN DEVICE	05
OPERATION	06
CHARGER CONNECTION	09
EXPLODED VIEW	10
SPARE PARTS	13
SPARE PARTS LIST	17
SERVICE	18
CUSTOMER SERVICE	18



ITEMS & TOOLS REQUIREMENT

RADIO SET



TOOLS NEEDED FOR ASSEMBLY

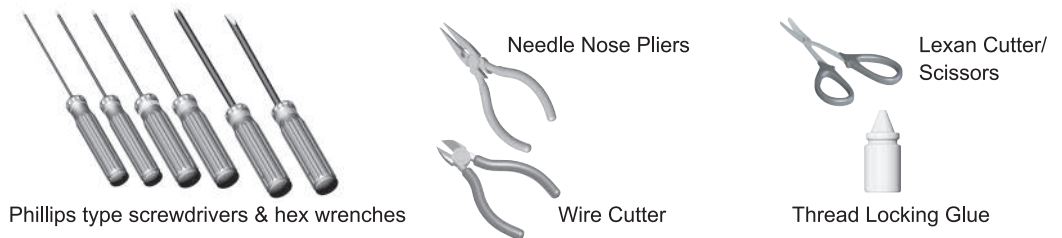

TOOLS INCLUDED IN KIT

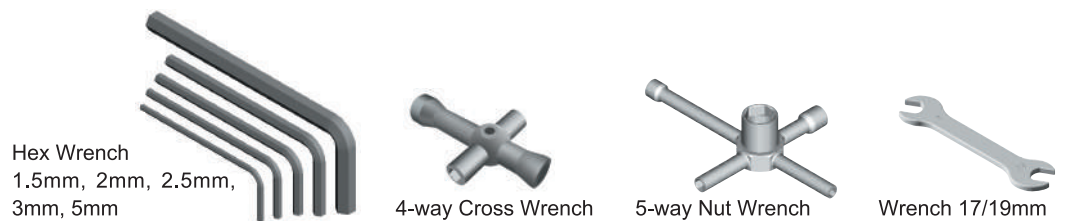

IMPORTANT NOTES & WARNING

RADIO



1. When turning radio on, first turn on the transmitter and extend the transmitter antenna.
2. Then turn on the receiver (The switch is located at the bottom of the front flange unit).
When turning off, first turn the receiver off, then the transmitter.

BATTERY CHARGING

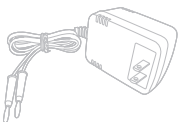

One 4S LiFe battery is included in the kit to supply the requiring power for all the electric equipment and drive system. DO NOT leave the charger unattended, DO NOT operate the charging process in flammable environment.

WARNING



1. This radio control submarine is not a toy. If not properly assembled and operated, it is capable of causing property damage. TTRobotix and it's distributor have no control over damage resulting from shipping, improper construction, or improper usage.
2. You must choose the suitable and safety area to operate the submarine. It is dangerous to drop the Seawolf into water.

CONFIGURATION

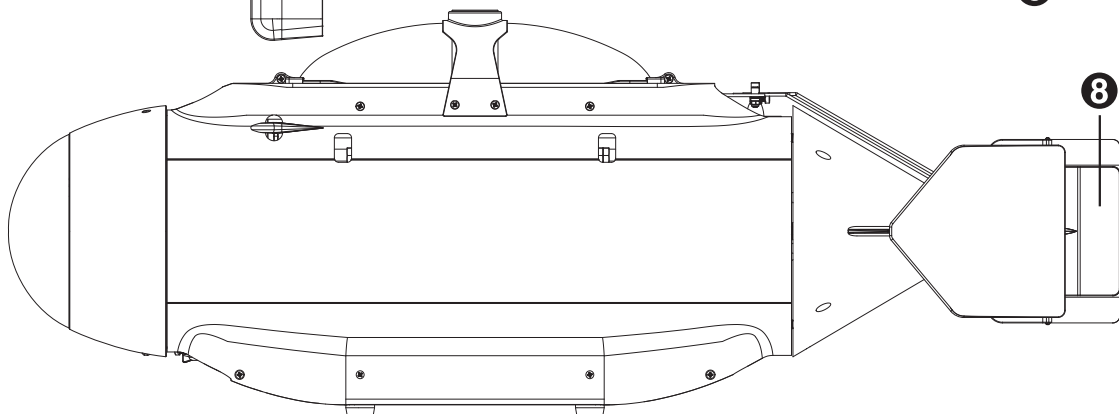
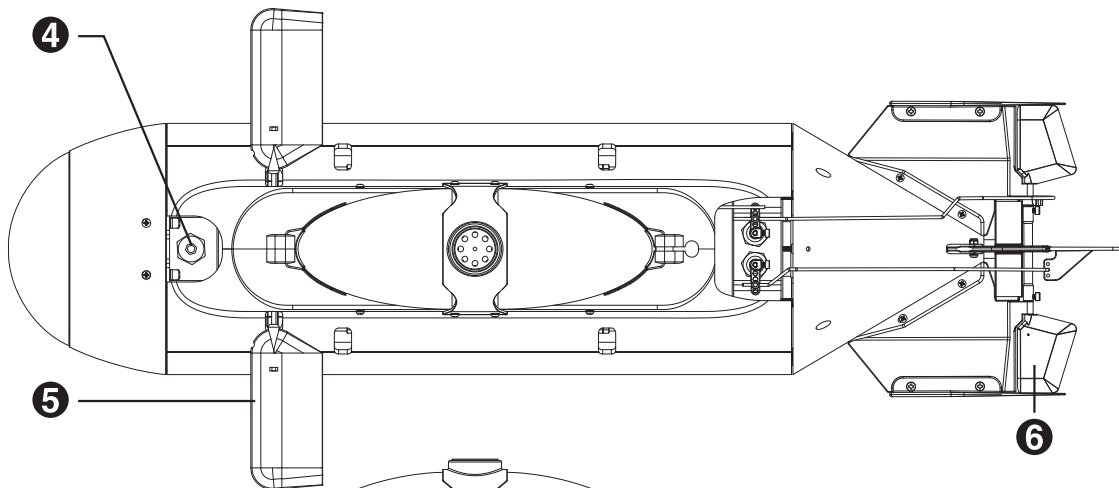
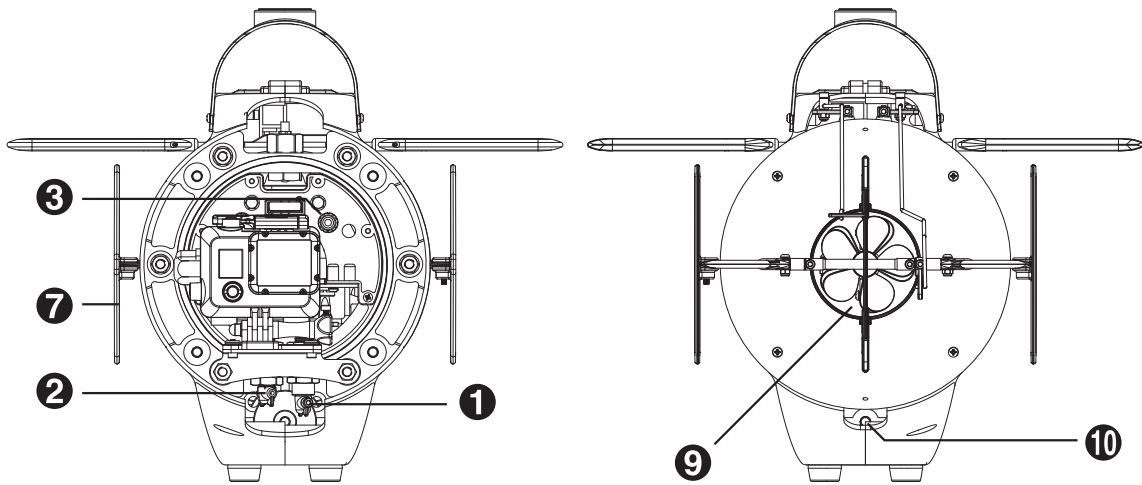

- | | |
|---------------------------|----------------------------|
| 1 Switch-Power On | 6 Rear Elevator |
| 2 Switch-Not in Used | 7 Verticle Stabilizer |
| 3 Charging Plug | 8 Rudder |
| 4 Control Cable Connector | 9 Propeller |
| 5 Front Elevator | 10 Water Inlet/Outlet hole |

RADIO CONTROL vs SUBMARINE MOVEMENT

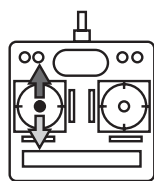

Throttle

Forward ←

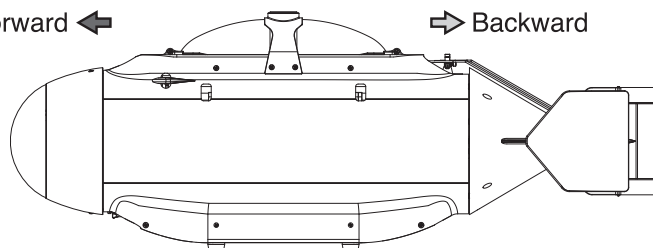

→ Backward

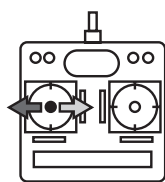

Floating / Diving

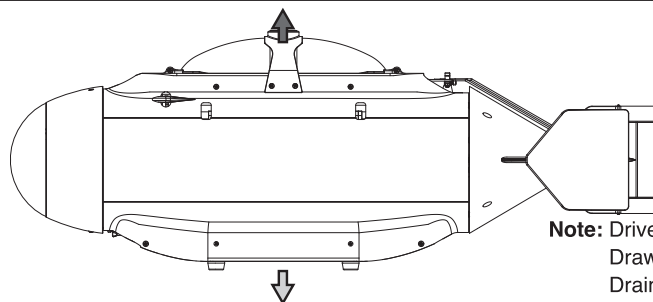

Note: Drive of water pump.
Draw water for diving.
Drain water for floating.

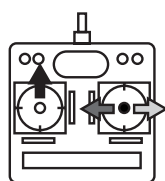

Steering
(Forward)

Right turn

Left turn

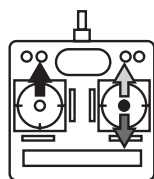
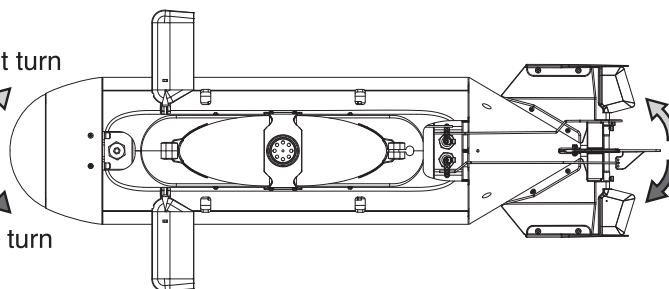

Elevator
(Forward)

Nose up

Nose down

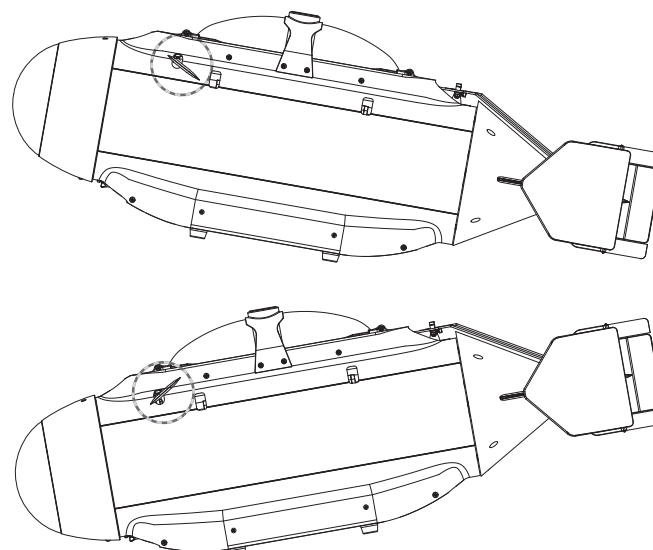

NOTE:

- 1) The radio show in the drawing is similar to MODE 2 of RC airplanes: throttle is at the left stick and elevator is at the right one. However, the stick radio easily allows to shift to Mode 1. Open the inner hull and exchange the servo connectors at the receiver.
- 2) Due to it's more difficult for the RF signal through the water(especially in sea water). The control distance is much shorter than the radio system operating on the surface. Base on our experience, maximum controllable depth for 40Mhz RF radio system is about 5M.

INTRODUCTION FOR THE MAIN DEVICE

■ LED INDICATION LIGHT

On the main control PCB unit, there are 3 LED lights are designed to show the current status of the Seawolf submarine. You can observe the light and refer to the following chart to get the light information.

Light Sign	Seawolf Status	Light Sign	Seawolf Status
<ul style="list-style-type: none"> ○ (Y) ○ (G) ○ (R) 	Yellow Light On-- <ul style="list-style-type: none"> • Water Pump On • Ballast Bag Filled • Diving 	<ul style="list-style-type: none"> ○ (Y) ○ (G) ● (R) 	Red Light On (Continuous) <ul style="list-style-type: none"> • Normal Operating
<ul style="list-style-type: none"> ○ (Y) ● (G) ○ (R) 	Green Light On— <ul style="list-style-type: none"> • Water Pump On • Ballast Bag emptied • Surface 	<ul style="list-style-type: none"> ○ (Y) ○ (G) ☀ (R) 	Red Light Flash <ul style="list-style-type: none"> • Low Battery • Tx signal lost • Water inside Hull

■ AUTO PROTECTING SYSTEM

Combined with a auto protecting system on the main PCB control board, if the system detects low battery power, low transmission signal, leakage(water inside hull), then the roll pump will auto start to flood the water out of the ballast tank to make the submarine float back to the surface. At the same time, the Red LED light will flash.

■ PUMP WITH BALLAST FOR THE STATIC DIVING SYSTEM

Base on the Archimedes principle—principle that states a body immersed in a fluid is buoyed up by a force equal to the weight of the displaced fluid. The principle applies to both floating and submerged bodies.

So base on this principle, equipped with a roll pump with ballast tank device in the inner hull, through the pump operating system to draw or drain the water into or out of the ballast tank to change the weight of the submarine. With suitable design of the volume and weight, then it is easy to operate the Seawolf diving or floating and even static stay under the water. So we call this the static diving system just like the real submarine.

The buoyancy of an object depends, therefore, only upon two factors: the object's volume, and the density of the surrounding fluid. So when you choose the difference water(with difference density) to play, you have to read-just the weight unit to make the submarine can be diving and floating smoothly and quickly. Normally, it need take about 50 seconds from floating to diving.

OPERATION

For fresh water use only.

■ POWER SWITCH

The main power switch is located at the bottom of the front flange. From the bottom view, the left switch is to control the main battery power for all the electric devices. The right switch is unused.

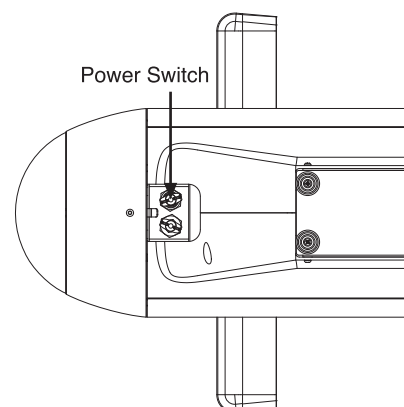

■ PREPARATION

Please follow the following procedures to do the preparation.

- 1) Check if there is no water inside the hull. If water is found inside the hull, the submarine shouldn't be used until you discover the cause of the problem and solve it.
- 2) Close the front cap and tighten the nuts (sequence: opposite nuts). After locking, the front O-Ring should appear uniformly flattened against the cap.
- 3) Switch on the transmitter and check TX battery status.
- 4) Switch on the submarine and check the following functions:
 - Check throttle: move left stick up/down and verify that full forward and reverse speed is reached. In centre position (idle) the propeller should not move. Correct TX trim if necessary
 - Check pump: move left stick right and left and verify that the pump starts running and inflates or empties the ballast. You may hear the noise of the motor and also feel the pump action by placing a finger at the water intake.

NOTE: Pump action is on-off and it's normal that it is not proportional. However, be sure that the centre idle position of the stick is equally far from left and right working position. Trim if necessary.

- Check dive planes (right stick up/down). Verify that stick neutral position corresponds to horizontal dive planes. Trim if necessary.
- Check rudder (right stick left right). Verify that stick neutral position corresponds to straight rudder. Trim if necessary.
- Switch off RX and TX respectively.

■ PRE-LAUNCH CHECK

- Switch on the transmitter. Check again TX battery status.
- Switch on the receiver (main switch). Check no interference from any other RC transmitter
- If the submarine doesn't switch on, check the fuse and replace if necessary.

NOTE: If the fuse is burnt again, then should be a short circuit inside. Don't use the model. Open it and search for any electrical problem)

- Check that the front hood is perfectly installed. If it isn't, any hit during the launch will cause it to fall down into the water. It will sink, being heavier than the water. Therefore, pay much attention. If the camera is not used, check that the cap of the cable connector is tightened. If the camera is used, see "Camera operation" paragraph.
- Start the pump and empty the bag (left stick to left), until the bag is totally emptied. This will be shown by the changed noise and the absence of air coming out from the water intake.

OPERATION

■ BUOYANCY CHECK & WEIGHT ADJUSTING

- Before using the submarine for the first time, check its correct buoyancy.
- Fill a bath tub with cold water and put the submarine into it
- With the ballast bag completely empty, the submarine should float keeping the turret and a thin part of the outer hull above the waterline. You can change the weight parts to get the suitable position.
- Check if the submarine has a good trim, staying horizontal and without listing. If necessary adjust the ballast in the submarine keel. And, adjust the position of the weight parts to make the submarine level without pitch up or down.
- Please remember that different water conditions (for example, bath tub, swimming pool or lake) have an influence on the submarine trim due to different water density. Perform a buoyancy check any time you want to use the submarine in new places.

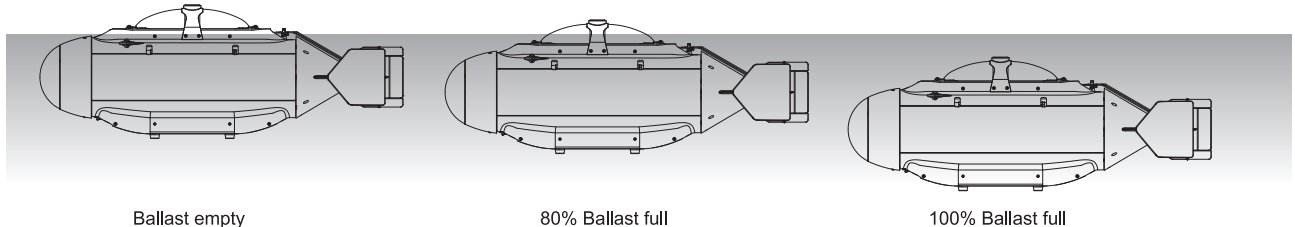

■ LAUNCH

- Find a good launch location, with the possibility to stand stable with no risk of falling into the water. The water surface should be easily reachable and must not be too low. Be careful with tide.
- Insert the handle into the holes of the external hull. Be sure that the hooks are connected to the metal rod of the inner hull and not only to the outer plastics .
- Lift the sub and gently place it into the water.
- Wait until the front hood and the rear cone are totally full of water. These are free-flood compartments and it's normal they become totally full of water, no large air bubble should remain inside them.
- At this point, disconnect the handle.

NOTE: Pay attention not to let the handle fall into the water, it will sink!

- Start piloting your Seawolf.

■ RECOVERY

- Start the pump in order to have the ballast bag completely empty
- Pilot the sub along the side of the swimming pool or lake, in a reachable position.
- Connect the hooks handle to the lifting points inside the slots of the hull. Be sure to clamp the inner metal rod and not only the plastic hull.
- Lift the submarine out of the water. During this phase, it will be significantly heavier, because of the water trapped between inner and outer hulls. Then, this water will be discarded and the operation will be simpler. Place the sub on a horizontal surface
- Switch the submarine and the transmitter off.
- Have a quick inspection of the hull and check no part has been damaged or lost.



OPERATION

■ OPERATION

- All the controls are described above.
- Rudder and throttle functions are similar to other R/C models.
- This submarine is capable to perform both static and dynamic dive.
- For a full static dive, keep the motor idle and start the pump flooding the bag. You will see the waterline at the turret become higher and higher until the entire submarine will be submerged and will go down vertically to the bottom. The opposite command will cause the pump to empty the ballast bag and the submarine will raise to the surface.
- Dynamic dive is possible thanks to the speed of the boat and the action of the dive planes. The ideal situation is reached when only the top ring of the turret is out of the water: at this point, start the motor full forward and set the dive planes to the “down” position: the submarine will dive and you will have dynamic control of the depth by operating the dive planes.
- Pay attention to any collision. If the submarine is running in a swimming pool or any other place with hard vertical walls, avoid any hit with these hard structures. The front elevator and hood might be damaged or even broken.
- Also, be aware to avoid algae, leaves or any other seaweed that may jam the propeller. If leaves or other are tangled around the propeller shaft, its efficiency will be greatly reduced and the stress on the motor will be much higher. This situation should be avoided in order not to have critical damages on the propulsion system.
- If the submarine raises to the surface on its own, it's possible that some safety function has switched on. Take the submarine out of water and check the alarm code from the LED indicator on the PCB.
- If the submarine raises to surface because of low battery, you will discover much lower motor power and no capability of diving. At this point, recover immediately the sub before the battery is completely empty (Please remember that the receiver is BEC-equipped and the power source is the same also for the electronics!).

MAINTENANCE AND PERIODICAL CHECK UP

- Remove the outer hull panels and clean every part.
- Before storing the submarine for a long time keep the inner hull open, disconnect the battery and fuse. Check the pressure sensor (try to over fill the ballast bag).
- Check the fail safe system (switch off the RC transmitter and see if the protection system activates).
- Check the low battery safety system.
- Check the integrity of inner hull. No cracks on inner tube.
- Check there is no leakage from the inner linkages and tubing.
- Check the dive planes and rudder operating angles. Adjust control rods and TX trims if necessary.
- Check the O-Ring status and correct tightening.
- Check operation of the switches and of all the other water proof exits. Devices must be tightened but must
- retain a smooth movement.

CHARGER CONNECTION

■ CHARGER CONNECTION STEPS

- Remove the fuse. Keep it in a safe place.
- Connect the charger to the AC power source.
- Connect the charging cables and balance board to the charger as shown.

CAUTION! Always: BLACK cable to the BLACK port, RED cable to RED port.

- Connect Red Cable to Red Jack on the Seawolf.
- Connect BLACK Cable to BLACK Jack on the Seawolf.
- Connect the balance cable of the battery to the balance board.
- The charger should begin to charge the battery. When charge is done, disconnect the cables in reverse order.
- Tight the front panel screws diagonally in order to seal the hull properly with even pressure. The front O ring should appear uniformly flattened against the cap.or the electronics!).

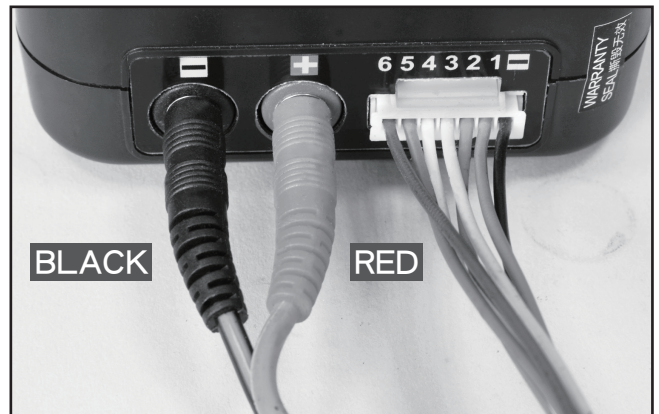
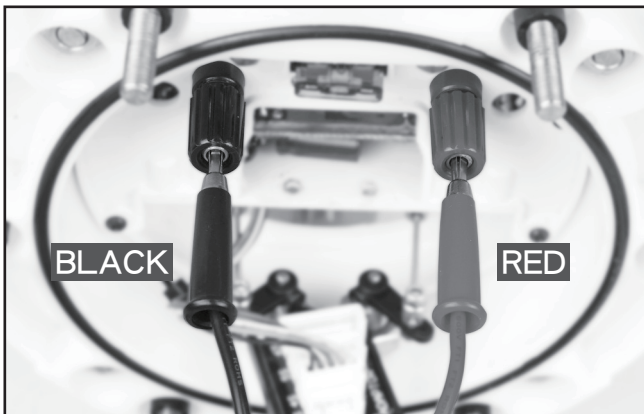

External & Body Assembly

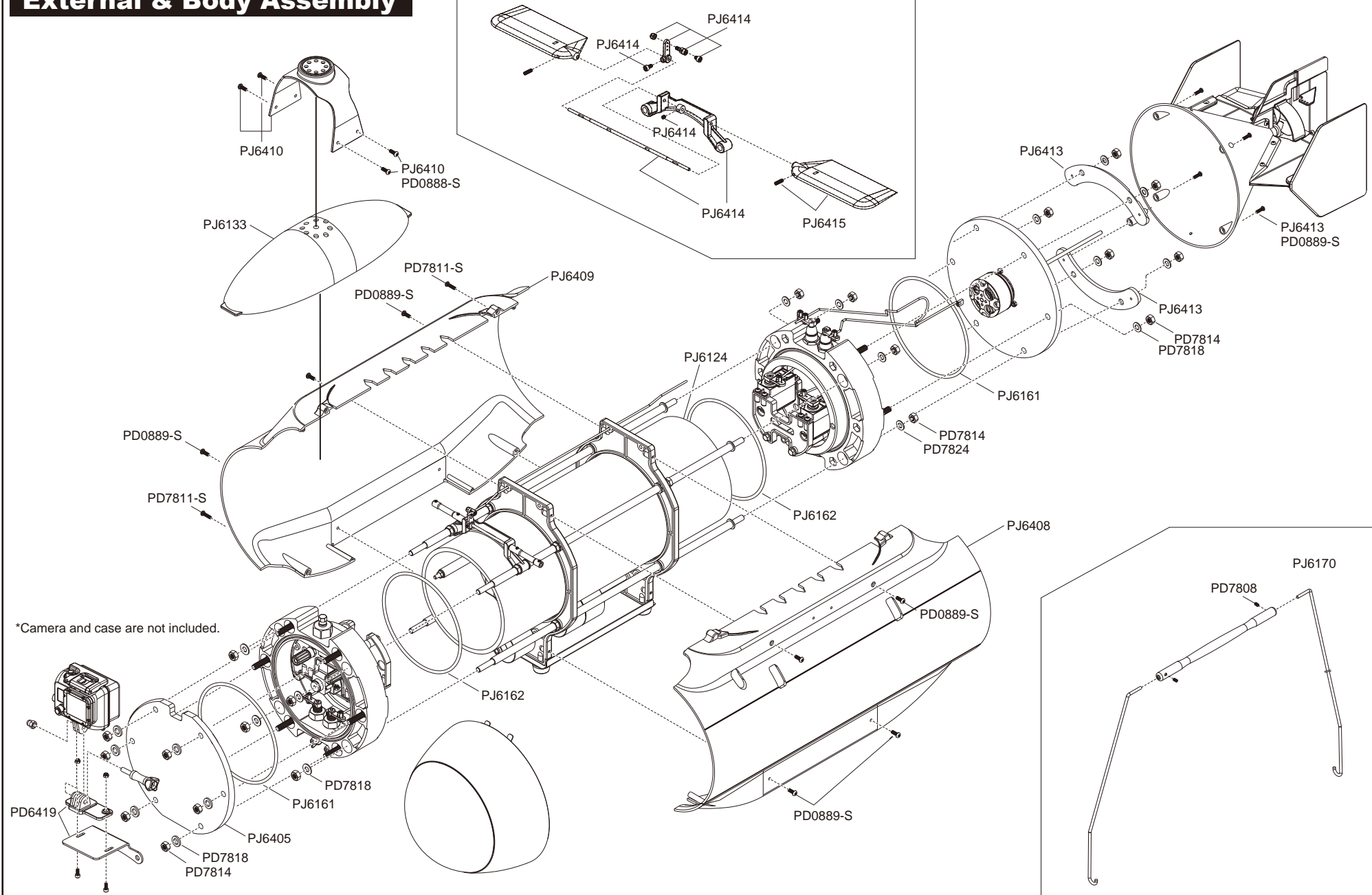

Inner Structure Assembly

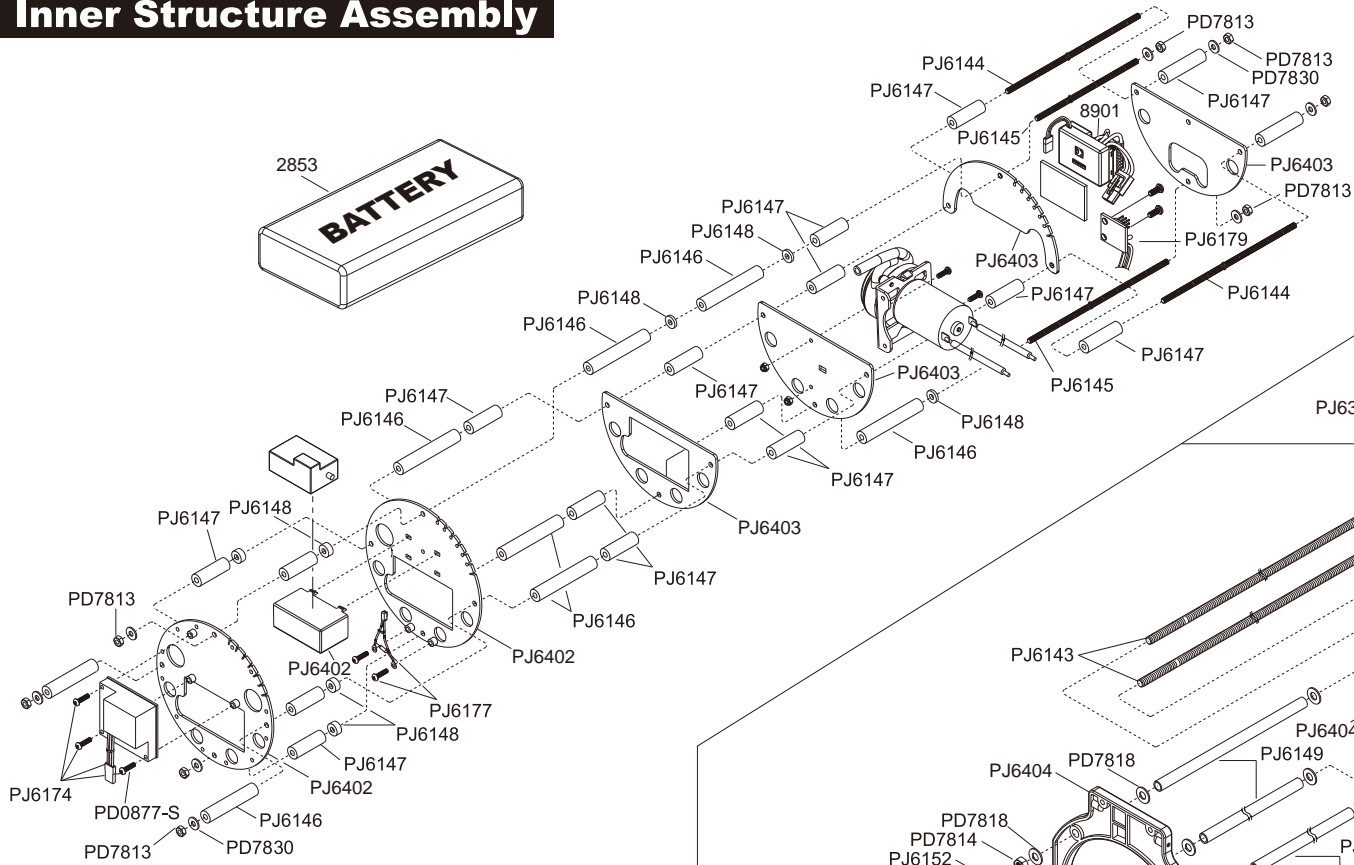

Drive System Assembly

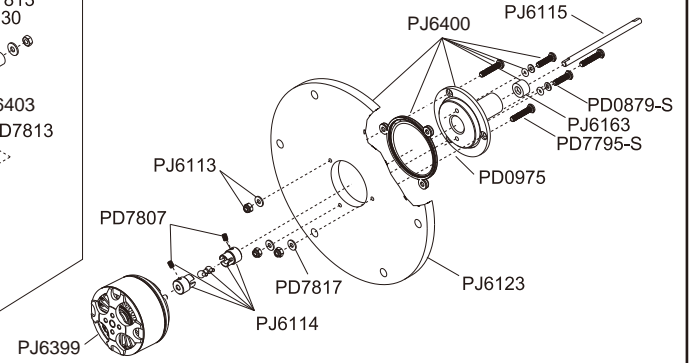

Pump & Ballast Assembly

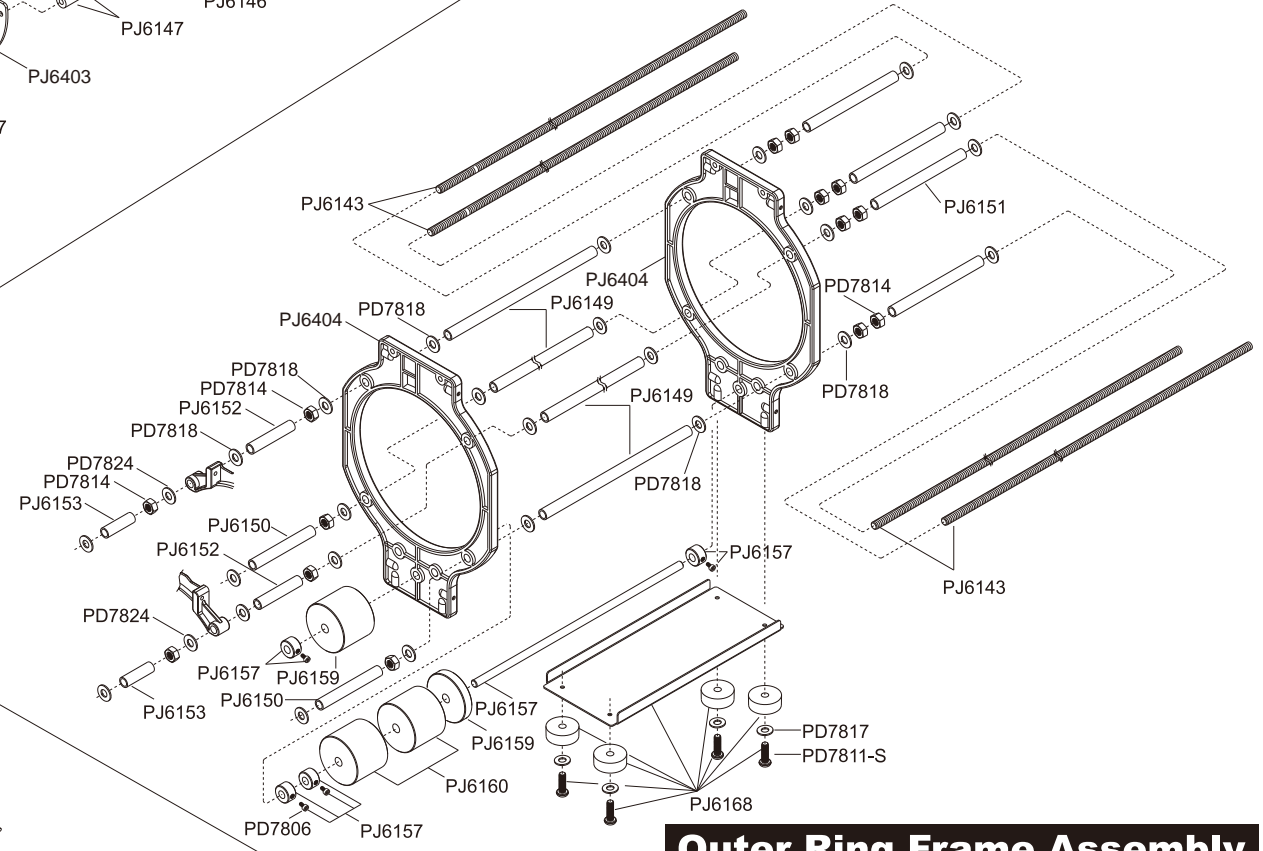
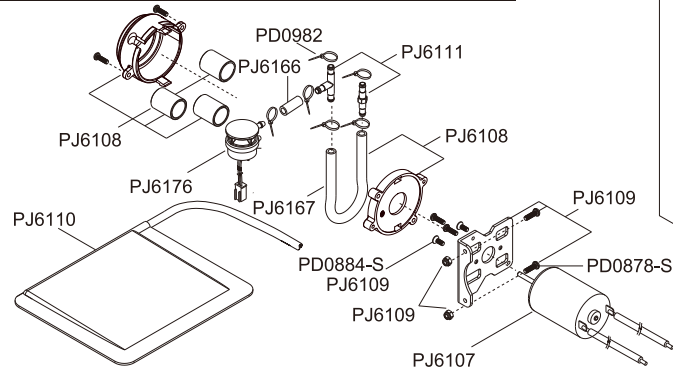

Outer Ring Frame Assembly

SPARE PARTS

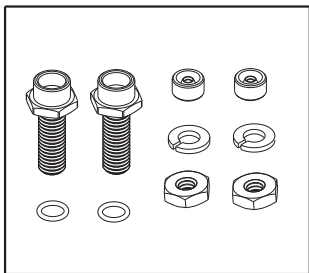

PJ6101 SEALED BOLT

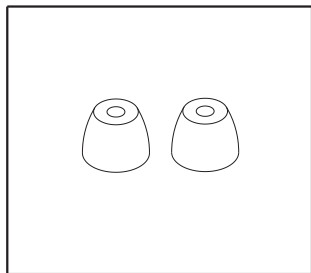

PJ6102 CONE RUBBER

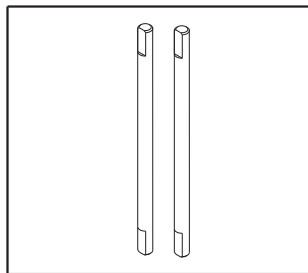

PJ6103 SWITCH LINKAGE ROD

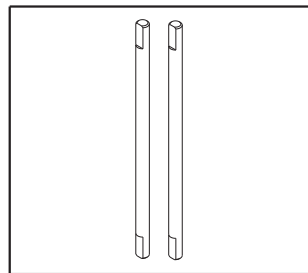

PJ6104 CONTROL LINKAGE ROD

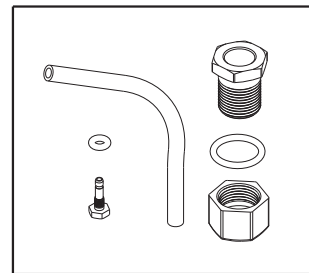

PJ6105 WATER INLET BOLT SET

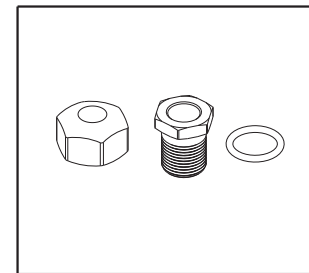

PJ6106 WATER PROOF BOLT SET

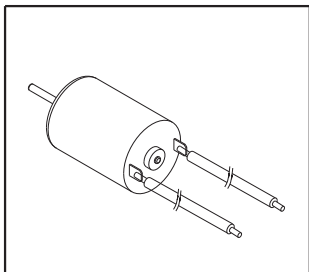

PJ6107 MOTOR SET,550

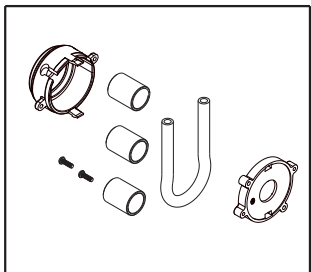

PJ6108 ROLL PUMP UNIT

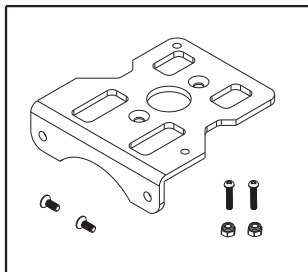

PJ6109 MOTOR MOUNT

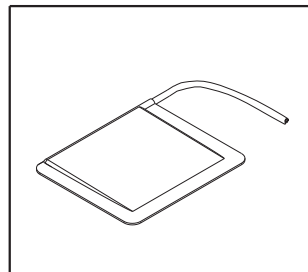

PJ6110 BALLAST TANK

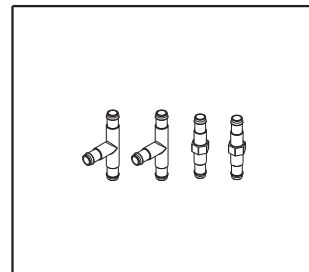

PJ6111 WATER TUBE CONNECTOR

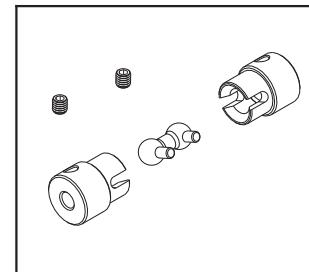

PJ6114 DRIVE CUP&SHAFT SET

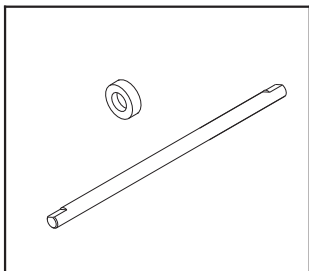

PJ6115 PROP DRIVE SHAFT

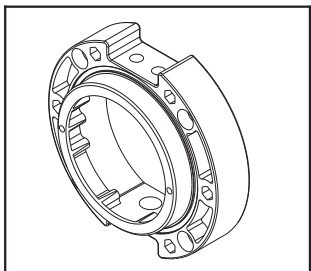

PJ6116 FR/RR FLANGE

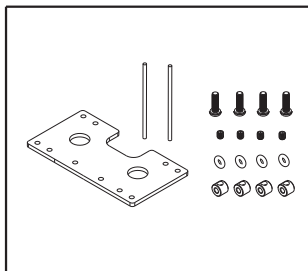

PJ6120 SWITCH MOUNT PLATE

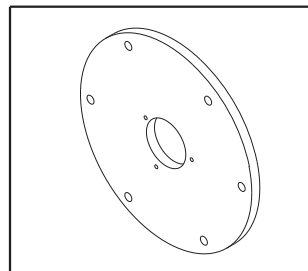

PJ6123 RR COVER PLATE

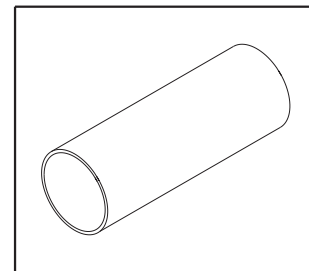

PJ6124 HULL MAIN TUBE

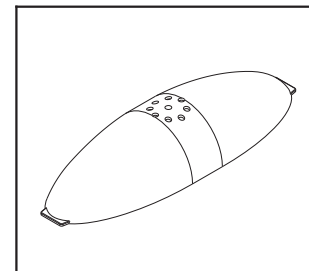

PJ6133 TOP MARINE CANOPY

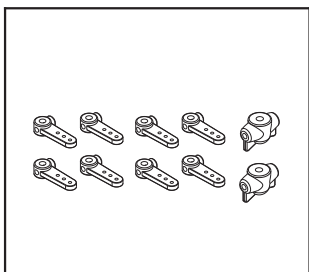

PJ6140 CONTROL ARM SET

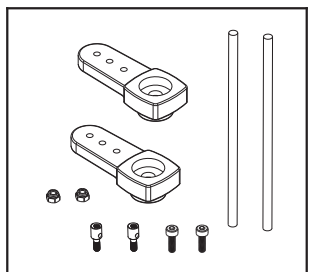

PJ6141 SERVO HORN&ROD

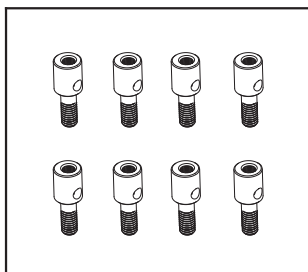

PJ6142 LINKAGE ROD MOUNT

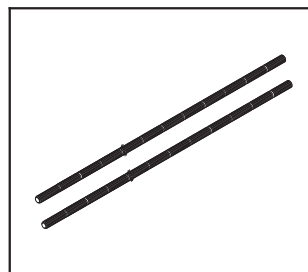

PJ6143 SCREW ROD(M6),L420

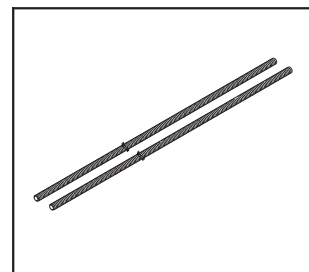

PJ6144 SCREW ROD(M4),L340

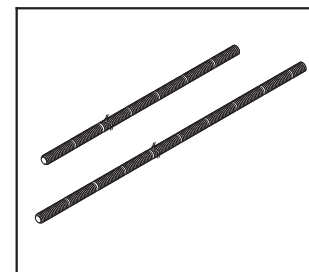

PJ6145 SCREW ROD(M4),
L240&L210

SPARE PARTS

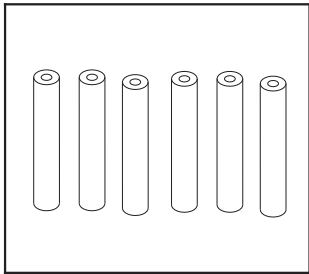

PJ6146 PLASTIC TUBE (6),L60

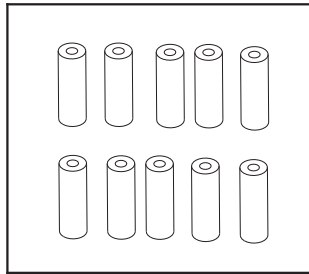

PJ6147 PLASTIC TUBE (10),L30

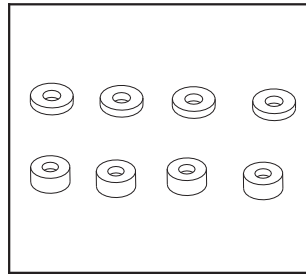

PJ6148 PLASTIC TUBE (8),L2&L6

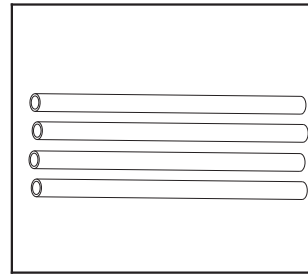

PJ6149 ALUM. TUBE(4),L150

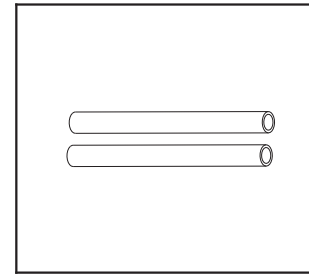

PJ6150 ALUM. TUBE(2),L101

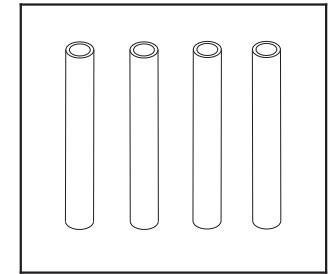

PJ6151 ALUM. TUBE(4),L96

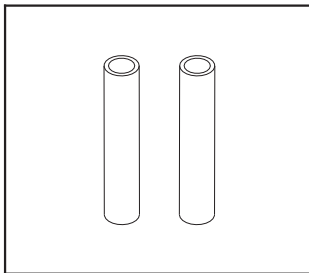

PJ6152 ALUM. TUBE(2),L41

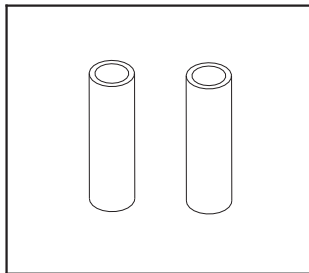

PJ6153 ALUM. TUBE(2),L38

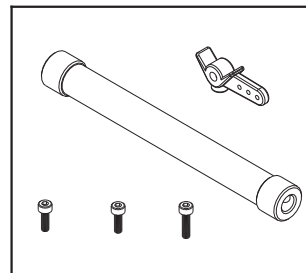

PJ6155 RR ELEV. MOUNT TUBE

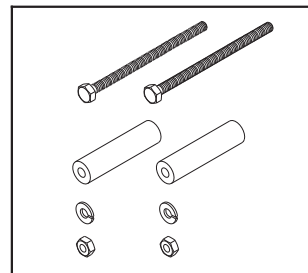

PJ6156 HEX MOUNT BOLT

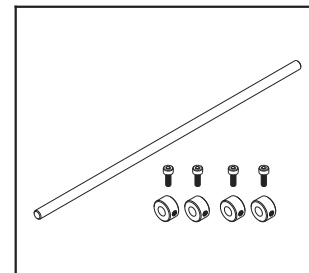

PJ6157 WEIGHT MOUNT ROD

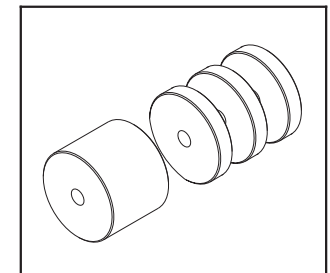

PJ6159 WEIGHT/A,WT416G

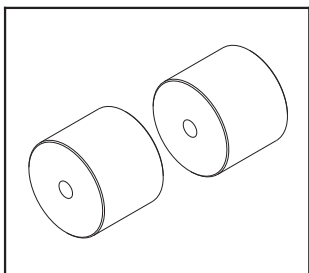

PJ6160 WEIGHT/B(2),WT740G

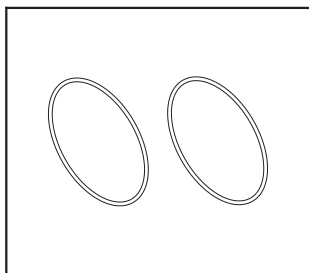

PJ6161 O-RING(2), ϕ 124mm

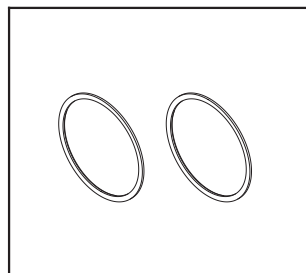

PJ6162 O-RING(2), ϕ 120mm

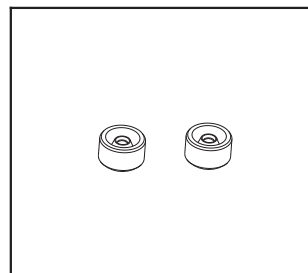

PJ6163 SEALED RUBBER/L(2)

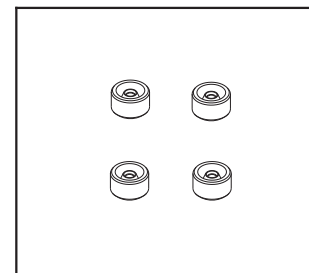

PJ6164 SEALED RUBBER/S(4)

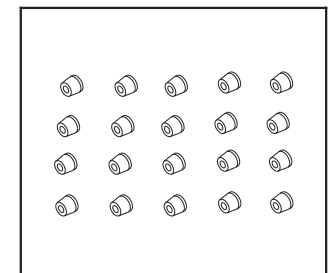

PJ6165 CONE RUBBER(20)

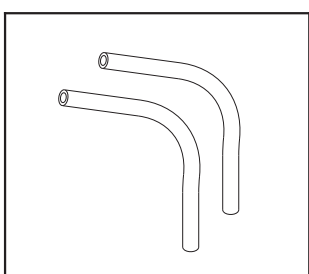

PJ6166 WATER TUBE,D6xd3x300

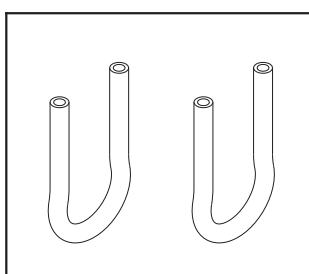

PJ6167 WATER TUBE,D7xd4x220

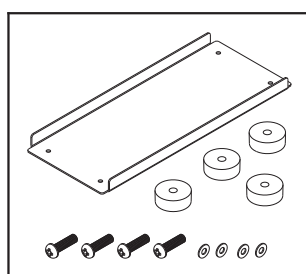

PJ6168 BOTTOM PLATE

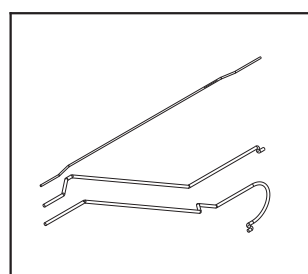

PJ6169 LINKAGE ROD SET

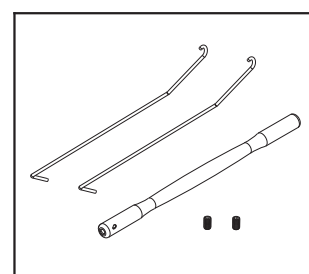

PJ6170 HANDLE BAR

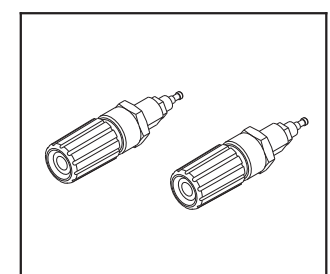

PJ6173 BINDING POST

SPARE PARTS

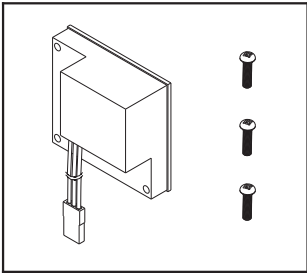

PJ6174 CONTROL PCB

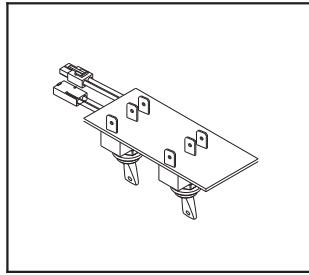

PJ6175 POWER DISTRIBUTION BOARD

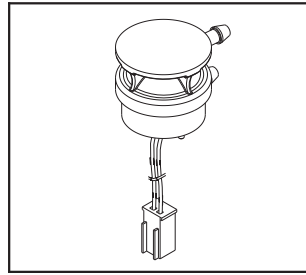

PJ6176 PRESSURE SENSOR

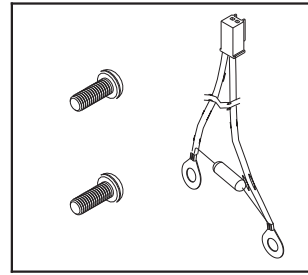

PJ6177 LEAKAGE SENSOR

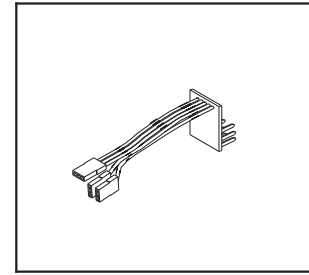

PJ6179 WIRE CONNECT CABLE

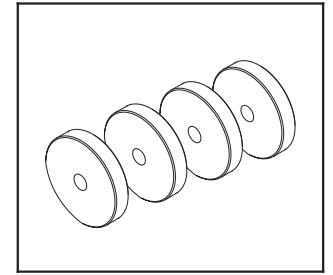

PJ6183 WEIGHT(4),WT120G

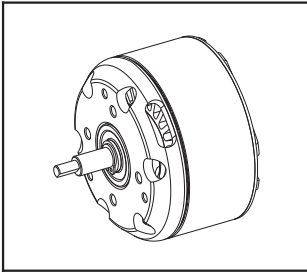

PJ6399 PROPULSION MOTOR

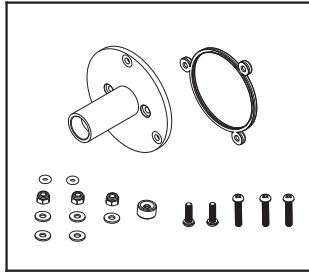

PJ6400 PROP. MOTOR MOUNT

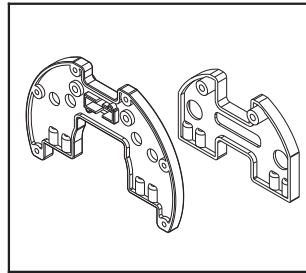

PJ6401 SERVO&H.W MOUNT

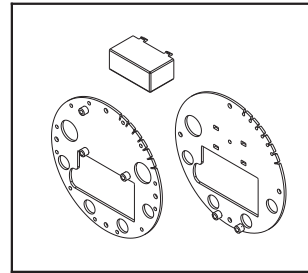

PJ6402 ROUND FRAME SET

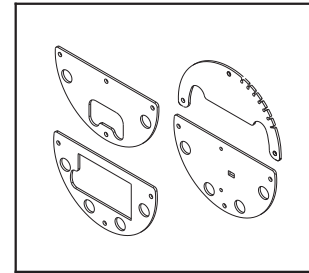

PJ6403 SEMI-ROUND FRAME SET

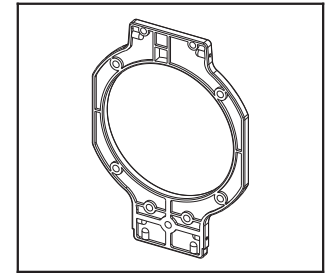

PJ6404 OUTER RING FRAME

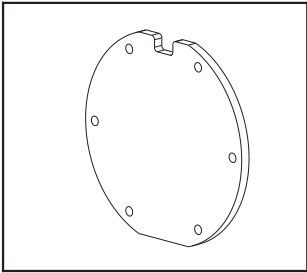

PJ6405 FR COVER PLATE

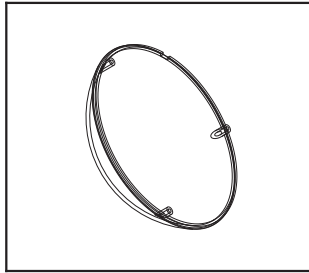

PJ6406 FR MARINE CANOPY

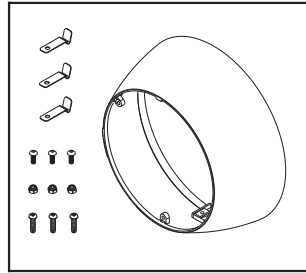

PJ6407 FR CABIN

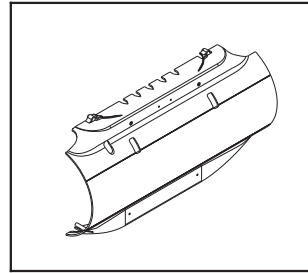

PJ6408 OUTER HULL(L)

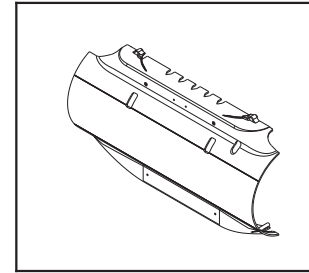

PJ6409 OUTER HULL(R)

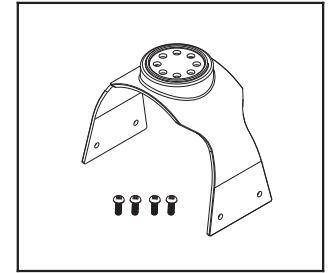

PJ6410 TOP CABIN FRAME

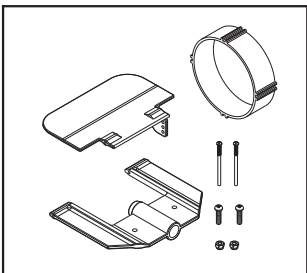

PJ6411 RR RUDDER BRACKET

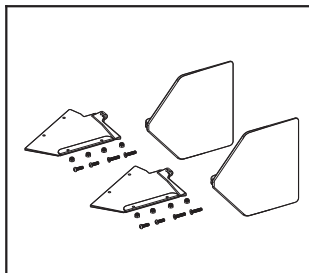

PJ6412 TAIL FIN SET

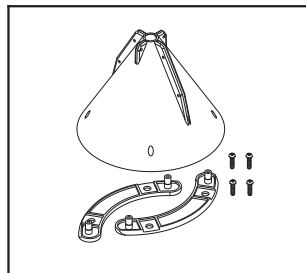

PJ6413 RR CONE FRAME

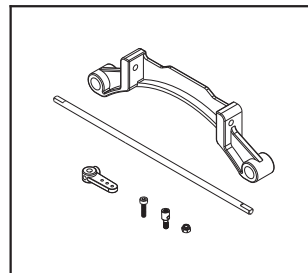

PJ6414 FR ELEVATOR BRACKET

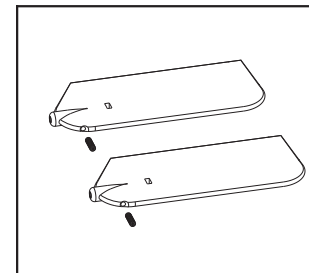

PJ6415 FR ELEVATOR SET

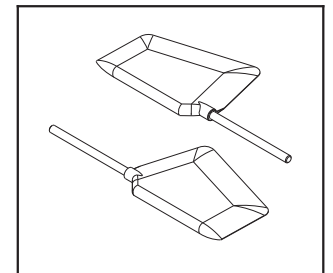

PJ6416 RR ELEVATOR SET

SPARE PARTS

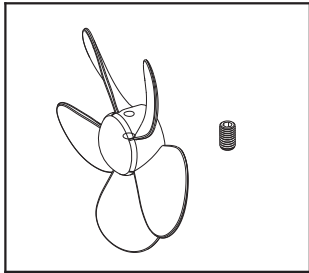

PJ6417 5 BLADE PROP.,D62x40

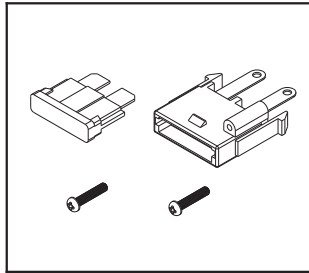

PJ6418 FUSE HOLDER

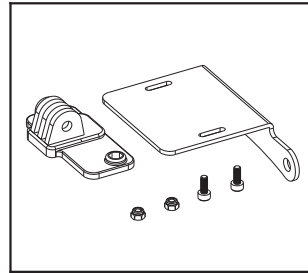

PJ6419 CAMERA BRACKET

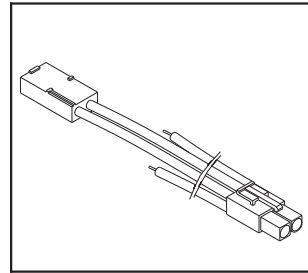

PJ6420 BATT. CONNECT WIRE

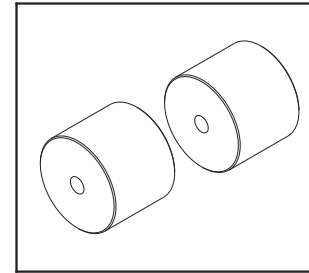

PJ6421 WEIGHT/C(2),WT540G



2540S CHARGER,6S



2853 LIFE BATTERY,5000mAh

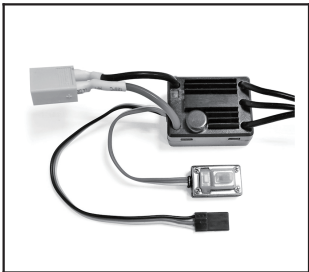

8091 ESC,BLC -25M

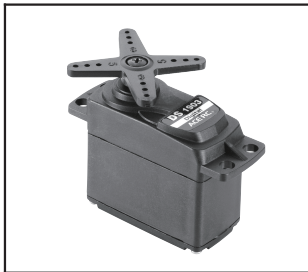

8175 STD SERVO/DS1903



8603S SEA WOLF COMMANDER

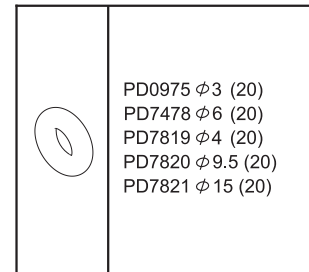

O-RING(20)

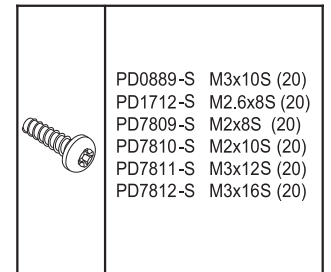

BT P. TAP SCREW

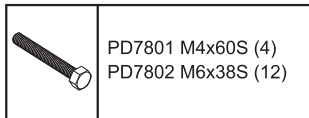

PD7801 M4x60S (4)
PD7802 M6x38S (12)

F.T P. MACH. SCREW

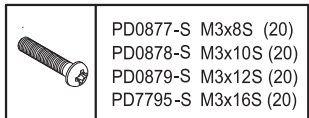

PD0877-S M3x8S (20)
PD0878-S M3x10S (20)
PD0879-S M3x12S (20)
PD7795-S M3x16S (20)

BT P. MACH. SCREW

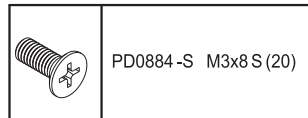

PD0884-S M3x8 S (20)

F.T P. MACH. SCREW, M3x8

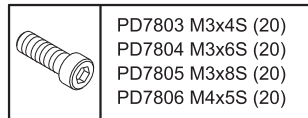

PD7803 M3x4S (20)
PD7804 M3x6S (20)
PD7805 M3x8S (20)
PD7806 M4x5S (20)

PDS.K MACH. SCREW

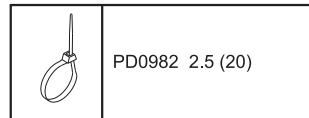

PD0982 2.5 (20)

NYLON STRAP(SMALL)

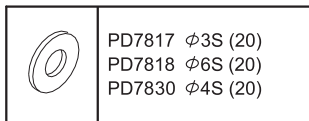

PD7817 ϕ 3S (20)
PD7818 ϕ 6S (20)
PD7830 ϕ 4S (20)

WASHER

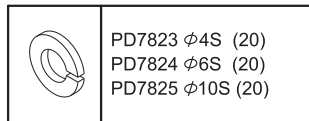

PD7823 ϕ 4S (20)
PD7824 ϕ 6S (20)
PD7825 ϕ 10S (20)

SPRING WASHER

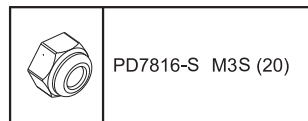

PD7816-S M3S (20)

LOCK NUT

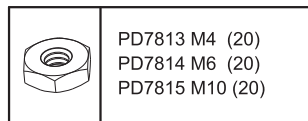

PD7813 M4 (20)
PD7814 M6 (20)
PD7815 M10 (20)

NUT

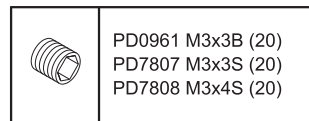

PD0961 M3x3B (20)
PD7807 M3x3S (20)
PD7808 M3x4S (20)

SET SCREW

SPARE PARTS LIST

PART#	DESCRIPTION	NOTE
PJ6101	SEALED BOLT	
PJ6102	CONE RUBBER	
PJ6103	SWITCH LINKAGE ROD	
PJ6104	CONTROL LINKAGE ROD	
PJ6105	WATER INLET BOLT SET	
PJ6106	WATER PROOF BOLT SET	
PJ6107	MOTOR SET,550	
PJ6108	ROLL PUMP UNIT	
PJ6109	MOTOR MOUNT	
PJ6110	BALLAST TANK	
PJ6111	WATER TUBE CONNECTOR	
PJ6114	DRIVE CUP&SHAFT SET	
PJ6115	PROP DRIVE SHAFT	
PJ6116	FR/RR FLANGE	
PJ6120	SWITCH MOUNT PLATE	
PJ6123	RR COVER PLATE	
PJ6124	HULL MAIN TUBE	
PJ6133	TOP MARINE CANOPY	
PJ6140	CONTROL ARM SET	
PJ6141	SERVO HORN&ROD	
PJ6142	LINKAGE ROD MOUNT	
PJ6143	SCREW ROD(M6),L420	
PJ6144	SCREW ROD(M4),L340	
PJ6145	SCREW ROD(M4),L240&L210	
PJ6146	PLASTIC TUBE(6),L60	
PJ6147	PLASTIC TUBE(10),L30	
PJ6148	PLASTIC TUBE(8),L2&L6	
PJ6149	ALUM. TUBE(4),L150	
PJ6150	ALUM. TUBE(2),L101	
PJ6151	ALUM. TUBE(4),L96	
PJ6152	ALUM. TUBE(2),L41	
PJ6153	ALUM. TUBE(2),L38	
PJ6155	RR ELEV. MOUNT TUBE	
PJ6156	HEX MOUNT BOLT	
PJ6157	WEIGHT MOUNT ROD	
PJ6159	WEIGHT/A,WT416G	
PJ6160	WEIGHT/B(2),WT740G	
PJ6161	ORING(2),Ø124MM	
PJ6162	ORING(2),Ø120MM	
PJ6163	SEALED RUBBER/L(2)	
PJ6164	SEALED RUBBER/S(4)	
PJ6165	CONE RUBBER(20)	

PART#	DESCRIPTION	NOTE
PJ6166	WATER TUBE,D6*d3*300	
PJ6167	WATER TUBE,D7*d4*220	
PJ6168	BOTTOM PLATE	
PJ6169	LINKAGE ROD SET	
PJ6170	HANDLE BAR	
PJ6173	BINDING POST	
PJ6174	CONTROL PCB	
PJ6175	POWER DISTRIBUTION BOARD	
PJ6176	PRESSURE SENSOR	
PJ6177	LEAKAGE SENSOR	
PJ6179	WIRE CONNECT CABLE	
PJ6183	WEIGHT(4),WT120G	
PJ6399	PROPULSION MOTOR	
PJ6400	PROP. MOTOR MOUNT	
PJ6401	SERVO&H.W MOUNT	
PJ6402	ROUND FRAME SET	
PJ6403	SEMI-ROUND FRAME SET	
PJ6404	OUTER RING FRAME	
PJ6405	FR COVER PLATE	
PJ6406	FR MARINE CANOPY	
PJ6407	FR CABIN	
PJ6408	OUTER HULL(L)	
PJ6409	OUTER HULL(R)	
PJ6410	TOP CABIN FRAME	
PJ6411	RR RUDDER BRACKET	
PJ6412	TAIL FIN SET	
PJ6413	RR CONE FRAME	
PJ6414	FR ELEVATOR BRACKET	
PJ6415	FR ELEVATOR SET	
PJ6416	RR ELEVATOR SET	
PJ6417	5 BLADE PROP.,D62x40	
PJ6418	FUSE HOLDER	
PJ6419	CAMERA BRACKET	
PJ6420	BATT. CONNECT WIRE	
PJ6421	WEIGHT/C(2),WT540G	
PD0877-S	BT P. MACH SCREW,M3X8S(20)	
PD0878-S	BT P. MACH SCREW,M3X10S(20)	
PD0879-S	BT P. MACH SCREW,M3X12S(20)	
PD0884-S	F.T P. MACH SCREW,M3X8S(20)	
PD0889-S	BT P. TAP SCREW,M3X10S(20)	
PD0961	SET SCREW,M3X3B(20)	
PD0975	O-RING,Ø3(20)	

PART#	DESCRIPTION	NOTE
PD0982	NYLON STRAP,2.5(SMALL,20)	
PD1712-S	BT P. TAP SCREW,M2.6X8S(20)	
PD7478	O-RING,Ø6(20)	
PD7795-S	BT P. MACH. SCREW,M3X16S(20)	
PD7801	F.T P. MACH. SCREW,M4X60S(4)	
PD7802	F.T P. MACH. SCREW,M6X38S(12)	
PD7803	PDS.K MACH. SCREW,M3X4S(20)	
PD7804	PDS.K MACH. SCREW,M3X6S(20)	
PD7805	PDS.K MACH. SCREW,M3X8S(20)	
PD7806	PDS.K MACH. SCREW,M3X5S(20)	
PD7807	SET SCREW,M3X3S(20)	
PD7808	SET SCREW,M3X4S(20)	
PD7809-S	BT P. TAP SCREW,M2X8S(20)	
PD7810-S	BT P. TAP SCREW,M2X10S(20)	
PD7811-S	BT P. TAP SCREW,M3X12S(20)	
PD7812-S	BT P. TAP SCREW,M3X16S(20)	
PD7813	NUT,M4(20)	
PD7814	NUT,M6(20)	
PD7815	NUT,M10(20)	
PD7816-S	LOCK NUT,M3S(20)	
PD7817	WASHER,Ø3S(20)	
PD7818	WASHER,Ø6S(20)	
PD7819	O-RING,Ø4(20)	
PD7820	O-RING,Ø9.5(20)	
PD7821	O-RING,Ø15(20)	
PD7823	SPRING WASHER,Ø4S(20)	
PD7824	SPRING WASHER,Ø6S(20)	
PD7825	SPRING WASHER,Ø10S(20)	
PD7830	WASHER,Ø4S(20)	
2540S	CHARGER,6S	
2853	LIFE BATTERY,5000mAH	
8091	ESC,BLC -25M	
8175	STD SERVO/DS1903	
8603S	SEA WOLF COMMANDER	

SERVICE

TTRobotix strives to bring you the highest level of quality and service we can provide. We test our products around the world to bring you state-of-the-art products. TTRobotix guarantees that you should enjoy many hours of trouble free use from our R/C products. TTRobotix products have been sold worldwide through the authorized distributors that are supported directly and rapidly from TTRobotix. You may find that TTRobotix is always pursuing to explore new items creatively with highest quality. To update the latest product information and to get the best technical support, please feel free to contact your local hobby shops or TTRobotix authorized distributor.

CUSTOMER SERVICE

■ North America

Distributed by :
HRP Distributing
2034 South 3850 West Salt Lake City,
UT 84104 USA

For customer service please contact
Support@trobotixusa.com
Support@thundertigerusa.com
Tel : 1-844-887-6268
Attn : TT Support

■ Germany, Netherlands, Belgium, Luxembourg, Austria, Italy

Distributed by / Vertrieb :
THUNDER TIGER EUROPE GmbH,
Rudolf-Diesel-Str. 1, 86453 Dasing, Germany

For customer service please contact
service@thundertiger-europe.com

■ For Other Countries

Distributed by :
Thunder Tiger Corporation
No.7 6th Road, Industry Park,
Taichung, Taiwan 40755

For customer service please contact
service@thundertiger.com
Tel : 886-4-23591632



This product is not a toy. Before you assemble and use this product, please read this manual thoroughly.
This product and its contents may differ from the graphics shown on this manual and are subject to change without prior notice due to product improvements and specification changes.

More information can view the tutorial videos on our TTR official website (www.ttrobotix.com) or YouTube channel (<https://www.youtube.com/user/ThunderTigerVideo>)



THUNDER TIGER GROUP
thundertiger.com

Manufactured by :
Thunder Tiger Corp.(Ningbo)
28 Jin-Feng Road, Liang Hui
Industrial Park, Yuyao, Zhejiang
315400 China

JJ6212