

DJI MATRICE 100

User Manual

V1.6 2016.03

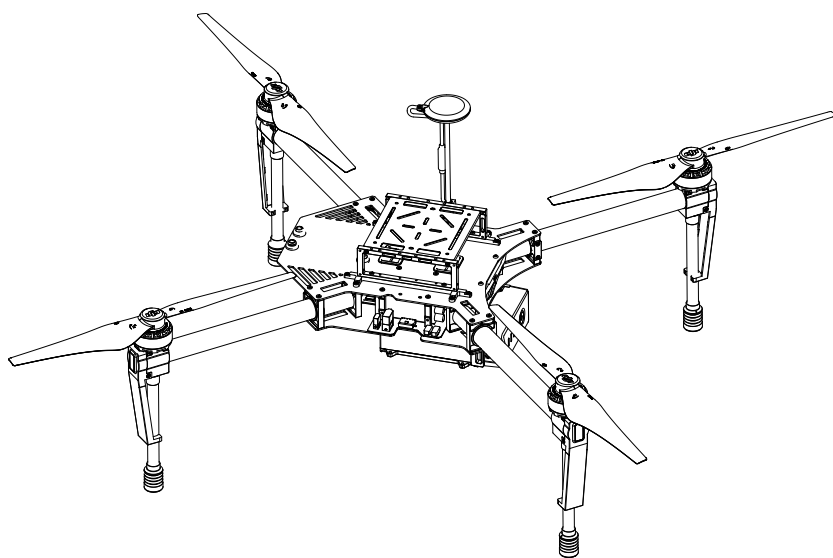

Searching for Keywords

Search for keywords such as “battery” and “install” to find a topic. If you are using Adobe Acrobat Reader to read this document, press Ctrl+F on Windows or Command+F on Mac to begin a search.

Navigating to a Topic

View a complete list of topics in the table of contents. Click on a topic to navigate to that section.

Printing this Document

This document supports high resolution printing.

Using This Manual

Legend

⚠ Warning

⚠ Important

💡 Hints and Tips

📖 Reference

Information

The DJI Matrice 100 does not include a gimbal or camera. The DJI Zenmuse X3, X5 series or XT Gimbal and Camera is required for certain functions mentioned in this manual.

Before Flight

The following tutorials and manuals have been produced to ensure you make full use of your DJI Matrice 100.

1. *DJI Matrice 100 In the Box*
2. *DJI Matrice 100 Disclaimer and Safety Guidelines*
3. *DJI Matrice 100 Intelligent Flight Battery Safety Guidelines*
4. *DJI Matrice 100 User Manual*

Check to see that you have all of the components listed in the *DJI Matrice 100 In the Box* manual. Before assembly, read the *DJI Matrice 100 Disclaimer and Safety Guidelines*. Complete the assembly with the help of this manual and the video tutorial on the DJI website (<http://www.dji.com/product/matrice100>).

Watch the Video Tutorials

Please watch the tutorial video below to learn how to install the DJI Matrice 100 correctly:
<http://www.dji.com/product/matrice100/info#video>



Download the DJI GO App

Download and install the DJI GO app before use. Scan the QR code or visit "<http://m.dji.net/djigo>" to download the app.

For the best experience, use mobile devices with Android 4.1.2 or above.
Requires iOS 8.0 or later.



Warnings

The rotating propellers can cause serious damage and injury. Fly with caution at all times.

Assembly Warnings

1. Ensure that all other parts are installed before inserting the Intelligent Flight Battery.
2. Use the extension rod to separate the GPS module from the center frame to avoid interference with the power board.
3. Ensure the frame arms are mounted correctly.
4. It is recommended to use the 3° fasteners to secure the frame arms. If you use the 0° fasteners, ensure that all four propeller rotation planes are perfectly horizontal after mounting.
5. Do NOT mix up the 0° fasteners and the 3° fasteners. Ensure the four fasteners in the outer arm slots of the center frame are the same.
6. Do NOT remove any glued-in screws.
7. Screws with blue glue on their threads can be used without threadlocker for the first time. After that, apply a suitable amount of threadlocker to the thread.

Flight Warnings

1. The aircraft is not waterproof. Do NOT fly in rainy or snowy weather.
2. Ensure that all parts are in good condition before each flight. Do NOT fly with worn or damaged parts.
3. Ensure that the cooling fan of the flight controller is in good condition and working properly before each flight. If not, repair it immediately.
4. Ensure the propellers and motors are installed correctly before each flight.
5. Ensure that all cables are secure before each flight.
6. Maintain a safe distance from people, buildings, high voltage power lines, tall trees, water, and other hazards when flying the aircraft.
7. Use only DJI TB47D/TB48D Intelligent Flight Batteries as the power supply.
8. Do NOT overload the system.
9. Do NOT go near or touch the motors or propellers when they are spinning, as this can cause serious injury.
10. Disconnect the battery and remove the camera during transportation to avoid damage or injury.
11. Only use compatible DJI parts.

If you encounter any problems or if you have any questions, please contact your local DJI authorized dealer or DJI Support.

DJI Support Website:
www.dji.com/support



Contents

Using This Manual	1
Legend	1
Information	1
Before Flight	1
Watch the Video Tutorials	1
Download the DJI GO App	1
Warnings	2
Assembly Warnings	2
Flight Warnings	2
Product Profile	5
Installation	5
Checking the Frame Arms	5
Checking the Center Frame	5
Mounting the Frame Arms	6
Mounting the Battery Compartment	9
Mounting an Extra Battery Compartment	14
Mounting the Expansion Bay	14
Mounting the GPS Module	15
Reserved Ports Description	16
Attaching the Propellers	18
Mounting the Gimbal (Optional)	19
Using the DJI Intelligent Flight Battery	23
Introduction	23
DJI Intelligent Flight Battery Functions	23
Using the Battery	24
Using the Remote Controller	28
Remote Controller Profile	28
Preparing Remote Controller	28
Remote Controller Diagram	29
Remote Controller Operation	31
Dual Remote Controllers Mode	35
Setting Up Dual Remote Controllers Mode	36
Remote Controller Status LED	38
Linking the Remote Controller	39
Remote Controller Compliance	40

Return-to-Home (RTH) and Dynamic Home Point	41
Return-to-Home (RTH)	41
Dynamic Home Point	43
DJI GO App	44
Equipment	44
Library	47
Explore	47
Me	47
Using the PC Assistant	48
Basic Setup	48
Simulator	49
SDK	49
Firmware Upgrade	50
Using the SDK	51
Flight	51
Flight Environment	51
Flight Limits and No Fly Zones	51
Pre-Flight Checklist	54
Flight Status Indicator	55
Calibrating the Compass	56
Auto Takeoff and Auto Landing	57
Starting and Stopping the Motors	57
Flight Test	58
Appendix	59
Product Specifications	59
Aircraft Status Indicator Description	61
Intelligent Orientation Control (IOC)	62
How to Upgrade the Firmware	63
Component Dimensions	65
DJI Zenmuse X3 Gimbal and Camera	68
DJI N1 Video Encoder	73
DJI Guidance System Mounting Warning	73
Compliance Information	74

Product Profile

The DJI Matrice 100 is a stable, flexible, and powerful flying platform. Its open platform and highly customizable design makes it suitable for a wide range of applications in the areas of research, business, and recreation.

The Matrice 100's expandable center frame makes it easy to mount additional components and devices to achieve greater functionality and results. An extra battery compartment for a second Intelligent Flight Battery can be installed to deliver an extended flight time of up to 40 minutes.

Developers are granted full control over their flying platform with the built-in API Control feature, giving them the freedom to customize a comprehensive aerial solution by using the DJI SDK.

Installation

Checking the Frame Arms

1. Ensure the motors are firmly attached to the frame arms, and can rotate freely.
2. Ensure the landing gear is firmly attached to the frame arms, and the antenna covers are in good condition.
3. Ensure that all cables are intact.
4. Identify the marks M1, M2, M3, and M4 on the four frame arms.

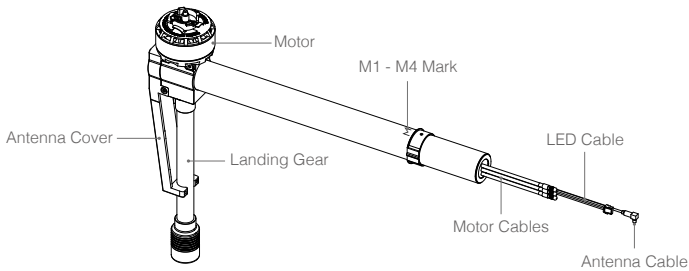

Checking the Center Frame

To check the center frame and connect the cables, first remove the upper plate and the battery compartment.

1. Remove the two screws (M3x8 self-tapping) on the Aircraft Status Indicator. Then gently remove the indicator to avoid damaging the cables.

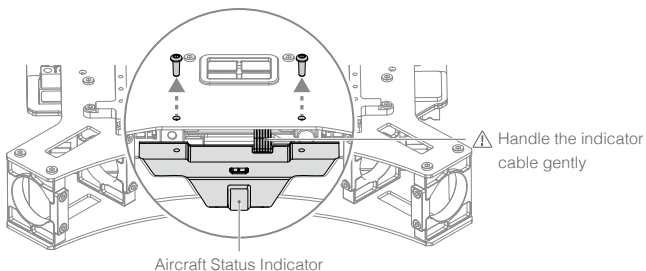

- Remove the eight screws (M2.5x8) on the mounting rails on the upper plate of the center frame. Then remove the mounting rails and the upper plate.
- Remove the four screws (M2.5x5) on the battery compartment. Then remove the battery compartment.

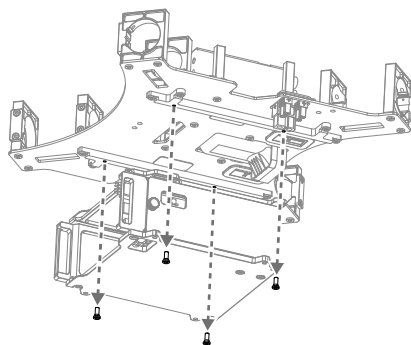
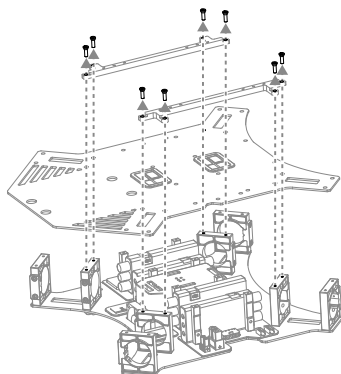

- Now you may check the center frame. Check that components such as the flight controller and ESCs are intact, and that the cables are connected to ports with matching color labels.

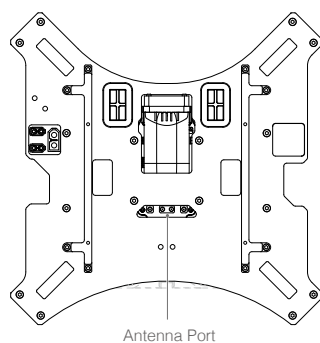
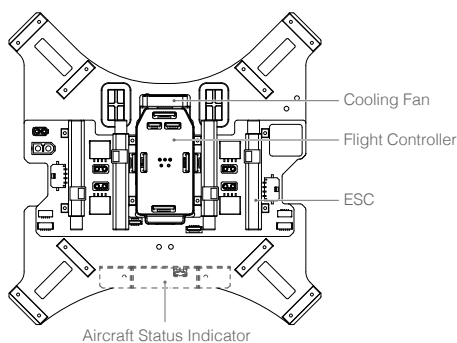

Mounting the Frame Arms

- Identify the M1 - M4 marks on the frame arms and the arm slots of the center frame. Mount each frame arm onto the corresponding position on the center frame.
- Arm Fasteners are used to secure the frame arms. There are three types of fasteners that come with the Matrice 100. The curved fasteners and the 3° fasteners are preinstalled on the arm slots.

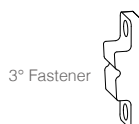
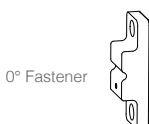
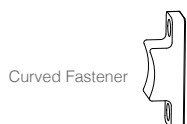

Curved Fastener: Fix on the inner arm slot.

0° Fastener: Fix on the outer arm slot so that the propeller rotation plane is perfectly horizontal.

3° Fastener: Fix on the outer arm slot so that the propeller rotation plane is at a 3° incline. It is recommended to use the 3° fasteners for a better flight experience.

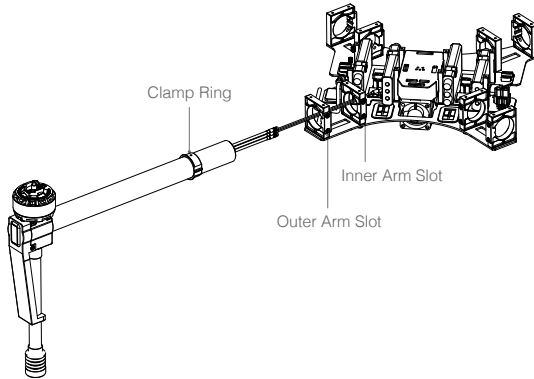

- 1) Loosen the four M2.5x5 screws on the curved fastener and the 3° fastener on each of the frame arms.
- 2) Insert each frame arm into the outer and inner arm slots successively until the clamp ring reaches the outer arm slot.
- 3) Rotate the frame arm so that the fin on the clamp ring fits perfectly into the slot of the 3° fastener. Then tighten the four screws to fix the curved fastener and the 3° fastener in place. Ensure the arrow on the 3° fastener is pointing upwards.



- If you choose to use the 0° fasteners, remove the 3° fasteners from the arm slots first. Ensure that all propeller rotation planes are perfectly horizontal after mounting the 0° fasteners.
- Do NOT mix up the 0° fasteners and the 3° fasteners. Ensure that the four fasteners on the outer arm slots are the same.

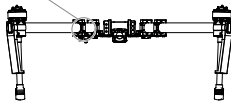
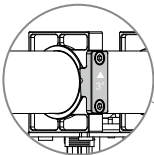

The 3° Fastener (with marking)

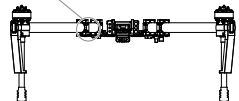
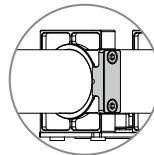

The 0° Fastener

3. Connect the three motor cables of each motor (M1 - M4) to the ports of its corresponding ESC. Be sure to match the color of the cables and ports.
4. Connect the LED cable of each frame arm to the port of its corresponding ESC.

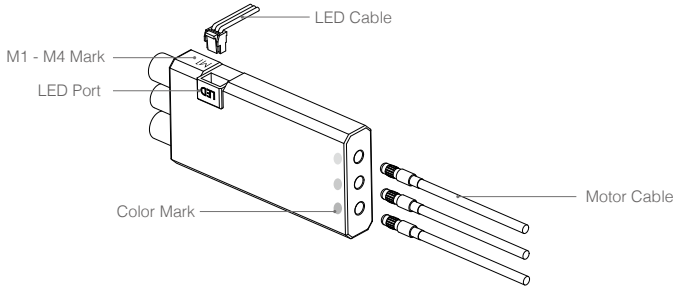

5. Pull the antenna cable of each frame arm through the cable tie on the lower plate of the center frame, and then connect each cable to its corresponding antenna port on the bottom of the flight controller (You may require some tools for this step). Note the arrangement of the antenna ports shown below.

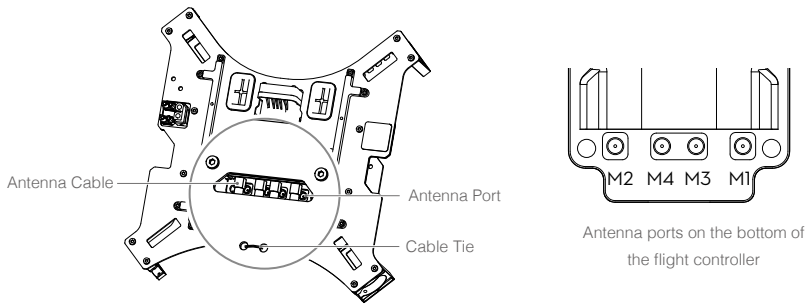

6. Ensure the motor cables, LED cable, and antenna cable of each frame arm are correctly installed to their corresponding ports.

- ⚠ • Be sure to match the color of each motor cable with its corresponding port. Wrong connections can cause the motor to rotate in the wrong direction.
- After connecting the antenna cables, tighten the cable tie to prevent the cables from coming loose.

7. Double check the positions of the frame arms. Frame arms M1 and M2 form the front of the aircraft, while frame arms M3 and M4 form its rear. Seen from the top, motors on frame arms M1 and M3 should rotate counter clockwise, while motors on frame arms M2 and M4 should rotate clockwise.

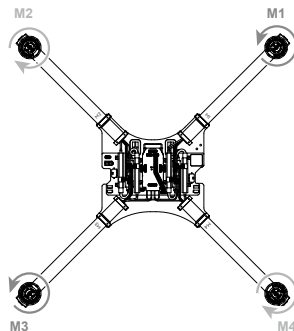

Mounting the Battery Compartment

Standard Mounting Position - Under the Center Frame

 If you are using the DJI Guidance system, it is recommended to mount the battery compartment on top of the center frame to avoid interference with the Guidance system. If you choose to mount the battery compartment under the center frame, disconnect the cable of the Guidance Sensor before accessing the Intelligent Flight Battery.

 The aircraft has been designed so that its center of gravity is optimized for the standard mounting position of the battery compartment. However, there is the option to adjust the longitudinal center of gravity by mounting the battery compartment at different positions along the top of the center frame. Refer to the next section on [Optional Mounting Position \(P12\)](#) for more details.

1. Pull the Aircraft Status Indicator cable, CAN cable, signal cable and power cable of the flight controller through the wire outlet on the lower plate of the center frame (refer to the right wire outlet in the figure below).

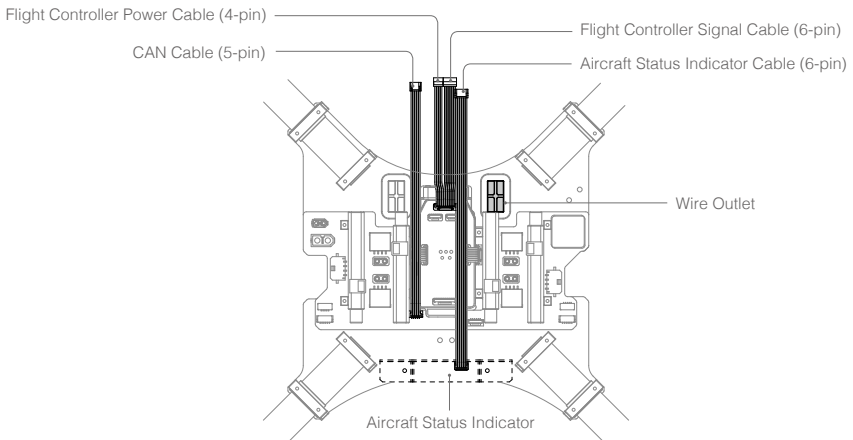

2. Re-mount the upper plate onto the center frame, and tighten the 16 screws (M2.5x5). Orientate the upper plate so that the notch faces the left of the aircraft (with its tail facing you). Then mount the mounting rails, and tighten the 8 screws (M2.5x8).

 If you are using the DJI Zenmuse X3 Gimbal and Camera, install the gimbal before mounting the upper plate. Refer to [Mounting the Gimbal \(P20\)](#) for more details.

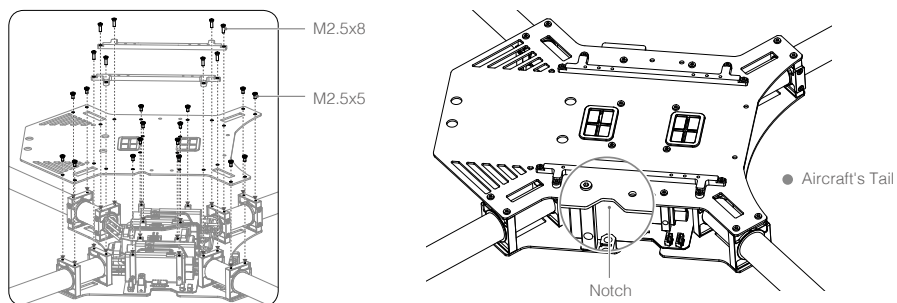

3. Re-mount the Aircraft Status Indicator, and tighten the two screws (M3x8 self-tapping). Do not overtighten the screws to avoid damaging the threads.

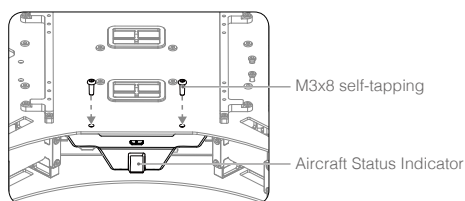

4. Mount the battery compartment (with the metal terminals facing the tail of the aircraft) onto the mounting rails on the lower plate of the center frame. Then tighten the four screws (M2.5x5).

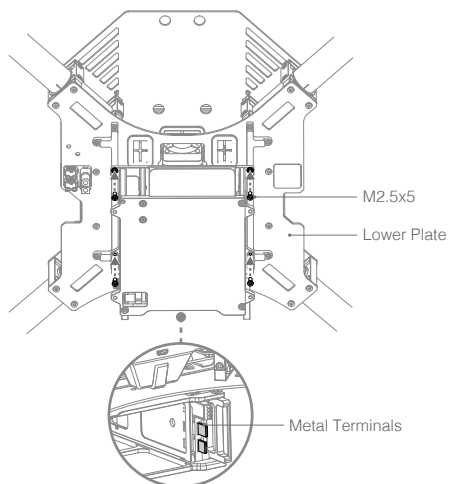

Optional Mounting Position - On Top of the Center Frame

1. Take the Aircraft Status Indicator cable, CAN cable, signal cable and power cable of the flight controller out of its existing wire outlet. Pull the cables through the wire outlet on the upper plate of the center frame instead.

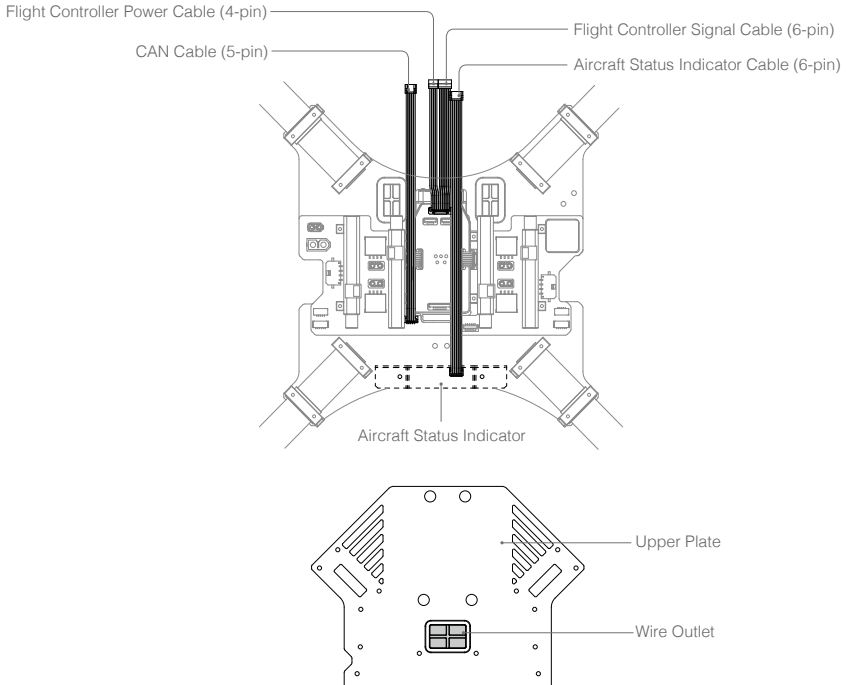

2. Re-mount the upper plate onto the center frame and tighten the 16 screws (M2.5x5). Orientate the upper plate so that the notch faces the left of the aircraft (with its tail facing you). Then mount the mounting rails and tighten the 8 screws (M2.5x8).

 If you are using the DJI Zenmuse X3 Gimbal and Camera, install the gimbal before mounting the upper plate. Refer to [Mounting the Gimbal \(P20\)](#) for more details.

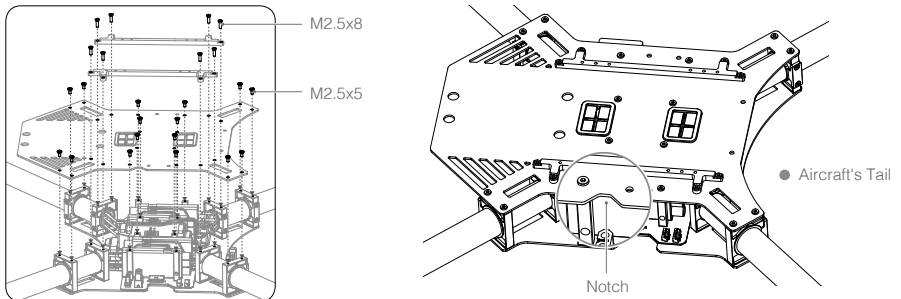

3. Re-mount the Aircraft Status Indicator and tighten the two screws (M3x8 self-tapping). Do not overtighten the screws to avoid damaging the threads.

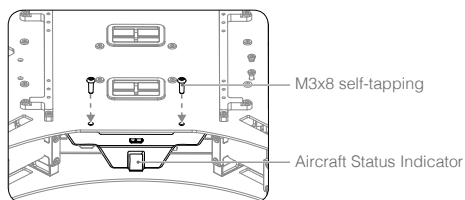

4. Mount the battery compartment (with the metal terminals facing the tail of the aircraft) onto the mounting rails on the upper plate of the center frame.
5. Adjust the aircraft's center of gravity by changing the position of the battery compartment along the mounting rails. Then tighten the four screws (M2.5x5).

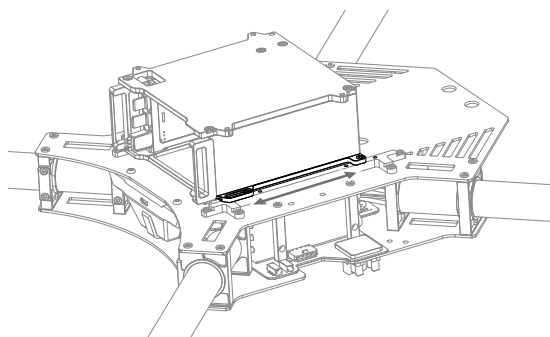

Cable Connection

1. Open the battery cover by removing the screw on the side of the battery compartment.

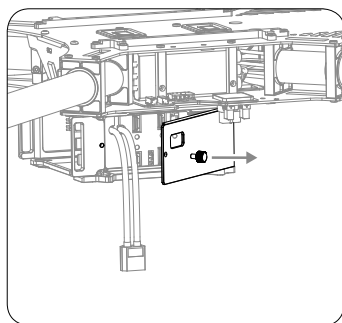

2. Connect the Aircraft Status Indicator cable to the 6-pin port.
3. Connect the power cable of the flight controller to the 4-pin port.
4. Connect the signal cable of the flight controller to the 6-pin port.
5. Connect the CAN cable on the lower plate to the CAN1 port.

-
- ⚠ • The 6-Pin port with a yellow sticker is reserved. Do NOT connect any cables to this port.
- Pull the above cables through the opening behind the battery cover, towards the nose of the aircraft, before connecting them.
-

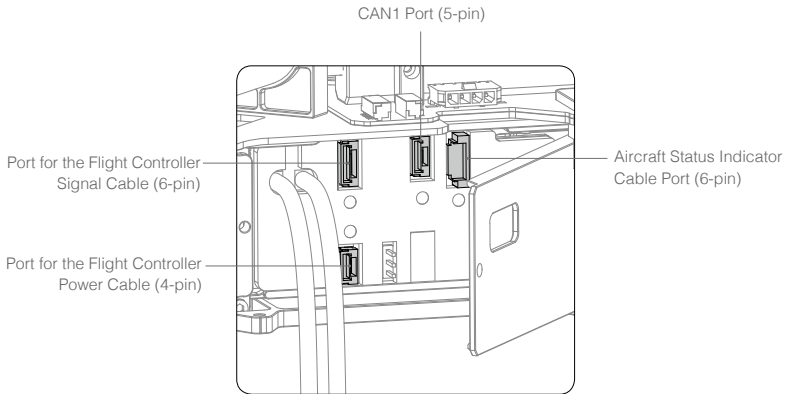

6. Pull the battery's power cable through the hole on the battery cover, and then connect it to the XT60 port on the center frame.
7. Close the battery cover and tighten the screw.

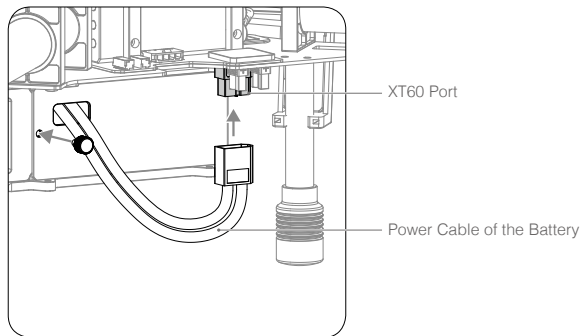

Mounting an Extra Battery Compartment

It is recommended to mount the extra battery compartment on the opposite side of the center frame. An extension cord may be required to connect the battery's power cable to the center frame.

1. Mount the battery compartment (with the metal terminals facing the tail of the aircraft) onto the mounting rails on the center frame. Then tighten the four screws (M2.5x5).
2. Connect the battery's power cable to the XT60 port on the center frame.



- When using two batteries, ensure that they have similar power levels.
- Always power on the battery which is connected to the flight controller first, otherwise the flight controller will not function properly.
- If the extra battery compartment is empty or if the Intelligent Flight Battery in the extra battery compartment is powered off, disconnect the battery power cable from the center frame before flight to avoid a short circuit.
- When upgrading the battery firmware, insert the Intelligent Flight Battery into the battery compartment which is connected to the flight controller. Upgrade firmware via the DJI N1 Assistant or a Micro SD card. Read [Upgrading the Firmware \(P63\)](#) in the Appendix for details.

Mounting the Expansion Bay

Extend the center frame of the Matrice 100 with the expansion bay to mount DJI modules such as the Guidance system or other products if necessary. Depending on your configuration, the expansion bay can be positioned on the top or bottom of the center frame, and mounted onto the mounting rails or the battery compartment.



- Only one side of the expansion bay base plate is smooth. Attach your gear to the smooth side of the base plate.
- Two sets of expansion bays come with the Matrice 100. One of them has mounting marks and a direction arrow to help you mount the DJI Guidance system.

1. Slide the base plate of the expansion bay into the slots of the two side plates. Then tighten the four screws (M2.5x5).

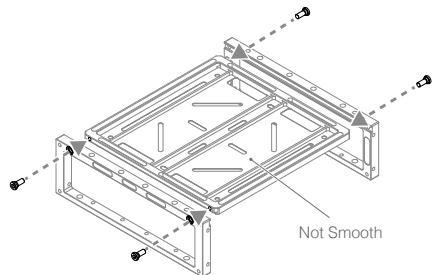
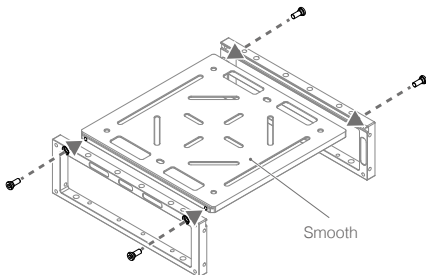

2. Mount the expansion bay onto the mounting rails and tighten the four screws (M2.5x5). Alternatively, mount the expansion bay onto the battery compartment and tighten the four screws (M3x5). The two mounting methods are illustrated in the figures below.

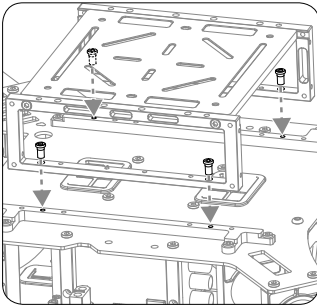

Mounting the expansion bay onto the mounting rails

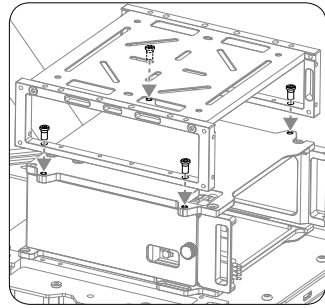

Mounting the expansion bay onto the battery compartment

3. Join two adjacent expansion bays using four screws (M3x5) as shown below.

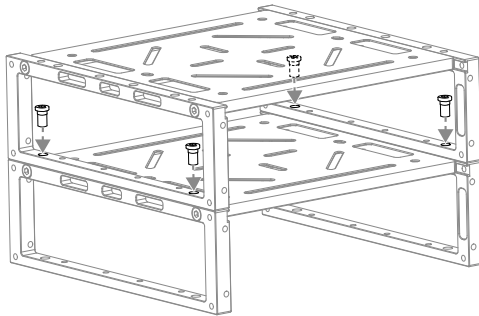

Mounting the GPS Module

1. Mount the collapsible GPS mount onto either side of the center frame using M2.5x8 screws.
2. Use the extension rod to attach the GPS module to the collapsible GPS mount. Ensure the arrow on the GPS module points to the nose of the aircraft (M1, M2). Avoid catching your fingers in the bracket when folding the collapsible GPS mount for transportation.

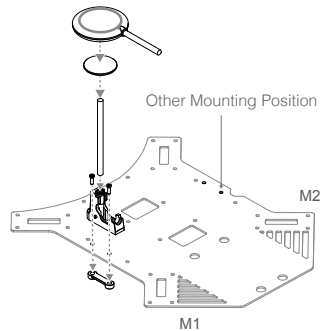

3. Mount the CAN HUB of the GPS module onto the upper or lower plate of the center frame.
4. Connect the GPS cable to the GPS CAN port on the center frame.

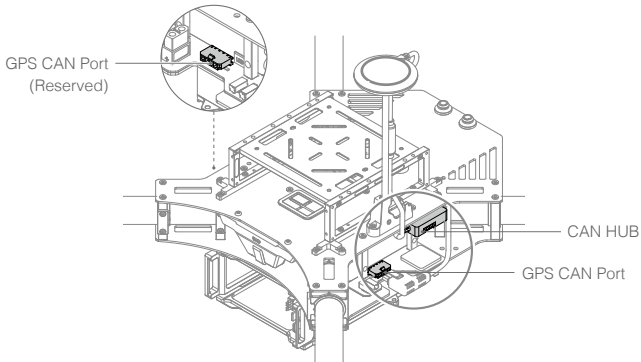

- ⚠ Use the extension rod to separate the GPS module from the center frame power board to avoid interference.
- Use glue to install the GPS extension rod. Ensure it is firm and stable before every flight.

Reserved Ports Description

There are five types of ports on the center frame. Connect your own devices to them accordingly.

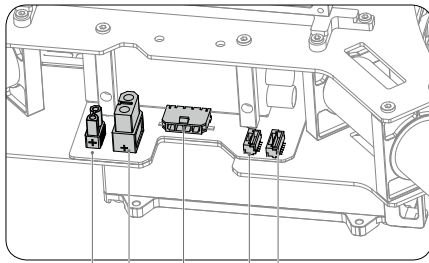

[1] [2] [3] [4] [5]

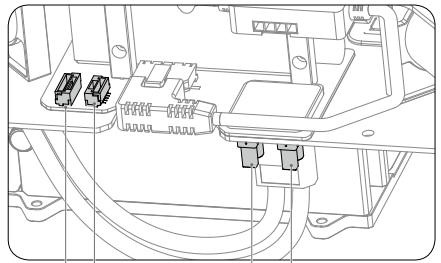

[5] [4] [1] [1]

- [1] XT30 Port [2] XT60 Port [3] GPS CAN Port [4] CAN-Bus Port [5] UART Port

- ⚠ Connect your own devices in strict accordance with the specifications of the reserved ports.

XT30 Ports and XT60 Ports

There are three XT30 ports and one XT60 port reserved on the center frame. You can supply power to your own devices by connecting them to these ports. Use the XT30-XT60 cable if necessary. Identify the positive and negative terminals of each port before connecting your device.

The specifications of these four reserved ports are as shown below:

Output Voltage: 20 - 26.1 V

Max Continuous Output Current: 10 A

-
- ⚠** The TOTAL current output of the reserved XT60 and XT30 ports (not including the XT60 port for the standard battery compartment) must not exceed 10 A.
-

CAN Ports and UART Ports

There is one GPS CAN port, two CAN-Bus ports (5-pin), and two UART ports (6-pin) reserved on the center frame. You can connect your own devices to these ports as required.

The pinout diagrams of the CAN-Bus port and the UART port are as shown below:

CAN-Bus Port (with a white dot besides pin 1):

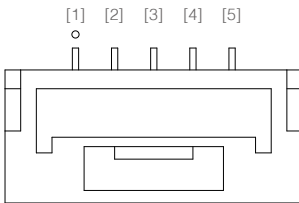

- [1] GND
- [2] CANL
- [3] CANH
- [4] GND
- [5] VCC 7.4 V

UART Port (with a white dot besides pin 1) :

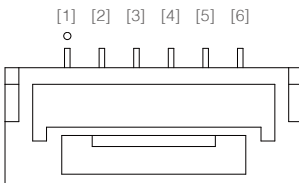

- [1] UART TXD
- [2] UART RXD
- [3] GND
- [4] CANL
- [5] CANH
- [6] VCC 6 V

-
- ⚠** Only use the provided UART cable to connect your own device to the UART port, as other cables can cause the flight controller or your device to be damaged from high voltage. DJI accepts no liability for damage or injury incurred from using third party cables.
-

Attaching the Propellers

Propeller Safety

1. Attach the propellers onto the correct motors stated in this manual. Rotation indicators are found on both the motors and the propellers to help you determine their direction of rotation. Show vigilance when attaching or detaching the propellers.
2. The propellers and the mounting plates may show signs of wear after continuous use. Inspect the hooks inside the propeller nut and the mounting plate, and replace the propeller or the mounting plate if necessary. If you have trouble identifying signs of wear, read Step 3 in the Installation section for more details.

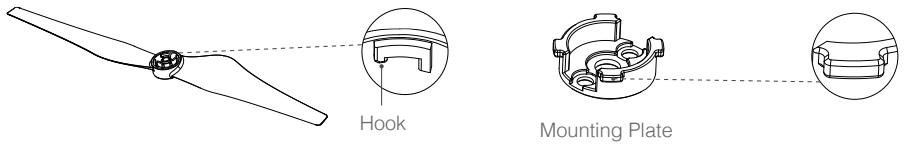

3. Ensure the mounting plate and the securing spring are firmly attached to the motor before every flight.
4. Ensure that all propellers are in good condition before every flight. Do NOT use old, chipped, or broken propellers.
5. Propellers should never be used after they have been involved in a crash or a collision. If such an event occurs, replace the propellers before flying again.
6. To avoid injury, stand clear of the propellers and motors when they are spinning.
7. The propellers, securing springs, and mounting plates have an approximate lifespan of 200 flights. Inspect them regularly to determine if they need replacement.
8. Only use official DJI propellers for a safer and better flying experience.
9. Handle the propellers with care.
10. Always follow the prescribed storage procedures to avoid damaging the propellers.

Installation

1. Attach the propellers with a white dot onto the mounting plate with a white dot, and attach the propellers without a dot onto the mounting plate without a dot.

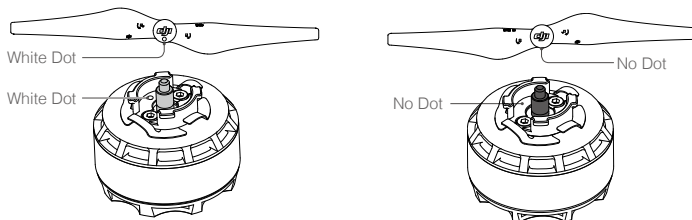

2. Align the hook (A) with the securing spring (B). While pressing the propeller onto the mounting plate, rotate the propeller in the lock direction  until it is secured.

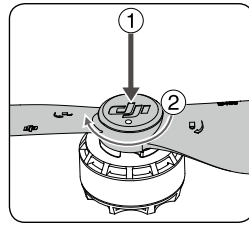
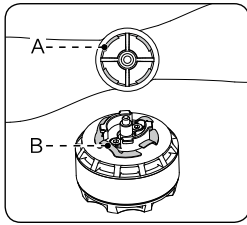

- Ensure you have followed the previous steps to install the propellers onto their corresponding mounting plates securely. To ensure the propellers are properly secured, hold the motor in place with one hand and use your other hand to rotate the propeller in the unlock direction without pressing down. If the propeller can be removed this way, the propeller and/or the mounting plate may have become worn and need to be replaced.

Press down on the propellers firmly, and then rotate it in the unlock direction (↺) to detach it from the motor.

Mounting the Gimbal (Optional)

- ⚠** The Matrice 100 and N1 Flight Controller is only compatible with the DJI Zenmuse X3, X5 series or XT Gimbal and Camera. Other gimbal systems will require custom configuration.

The following procedures apply to the DJI Zenmuse X3 and XT. For details on mounting the Zenmuse X5 series, refer to the DJI M100-Zenmuse X5 Series Gimbal Installation Kit Installation Guide. (<http://www.dji.com/product/matrice100/info#downloads>)

Mounting the Gimbal Lock and Connecting the Cables

- Remove the two screws (M3x8 self-tapping) on the Aircraft Status Indicator, and then remove the indicator gently to avoid damaging the cables.

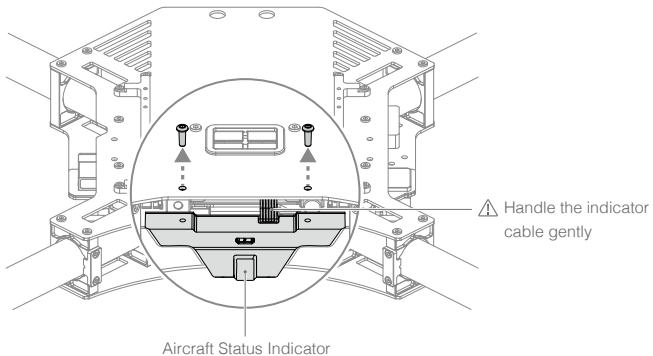

2. Remove the 16 screws (M2.5x5) on the upper plate of the center frame, and the eight screws (M2.5x8) on the mounting rails. Then remove the mounting rails and the upper plate.

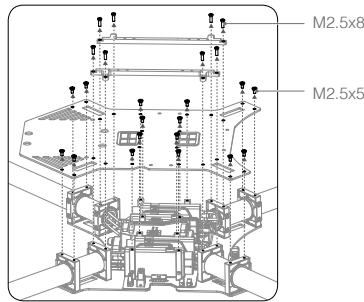

3. Connect one end of the 10-pin gimbal cable and 8-pin gimbal cable to the flight controller.

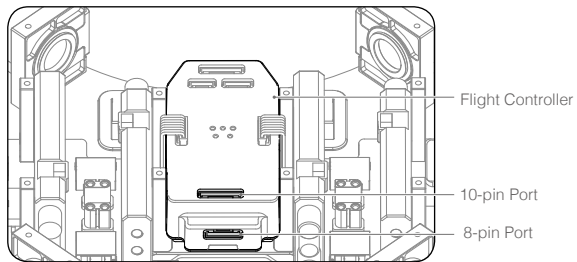

4. Arrange the other ends of the gimbal cables near the nose of the aircraft.

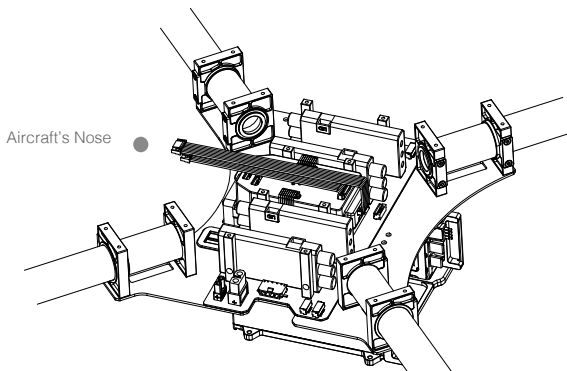

- Re-mount the upper plate of the center frame, and tighten the 16 screws (M2.5x5). Orientate the upper plate so that the notch faces the left of the aircraft (with its tail facing you). Then place the mounting rails and tighten the 8 screws (M2.5x8).
- Re-mount the Aircraft Status Indicator, and tighten the two screws (M3x8 self-tapping). Do not overtighten the screws to avoid damaging the threads.
- Attach the Gimbal Lock under the gimbal mounting plate. Then tighten the four Phillips screws.

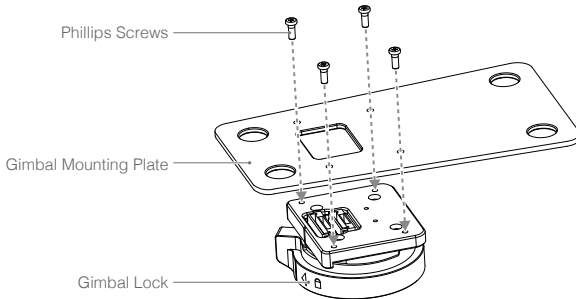

- Connect the other ends of the 10-pin gimbal cable and 8-pin gimbal cable to the corresponding ports on the Gimbal Lock.

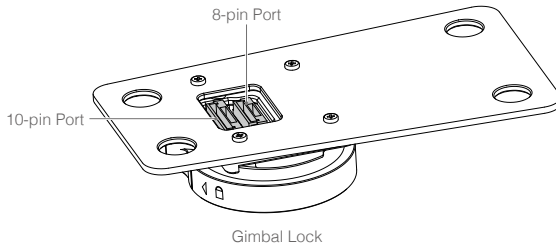

- Mount the gimbal mounting plate and dampers to the center frame.

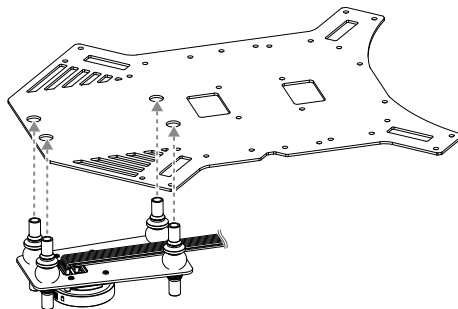



 The dampers may deteriorate over time. Ensure that all dampers are in good condition before every flight. Do NOT use worn or broken dampers.

The quick-release mount of the DJI Zenmuse X3 Gimbal and Camera allows you to attach and detach the camera with ease. Follow the instructions below:

Mounting the Gimbal and Camera:

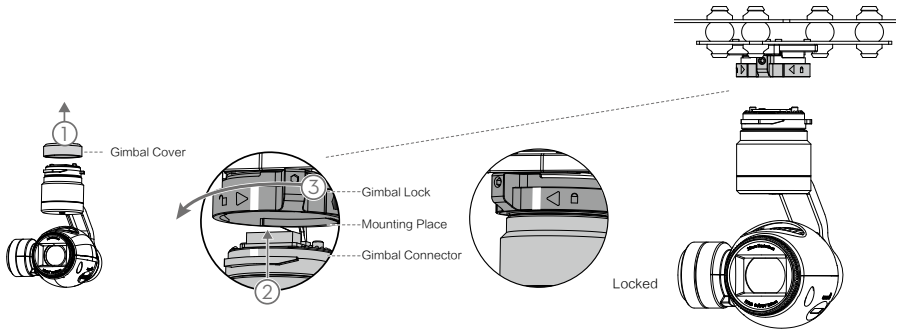
1. Remove the Gimbal Cover.
2. Rotate the Gimbal Lock to the unlocked position. Insert the gimbal by aligning the white marks on the gimbal and Gimbal Lock.
3. Rotate the Gimbal Lock back to the locked position. Ensure the gimbal is locked securely.



 Ensure the Micro SD card is inserted into the camera.

Removing the Gimbal and Camera:

While holding the upper part of the gimbal, rotate the Gimbal Lock to the unlocked position to remove the gimbal.

Using the DJI Intelligent Flight Battery

Introduction

The DJI Intelligent Flight Battery has a capacity of 4500mAh, voltage of 22.2V, and built-in smart charge-discharge functionality. It can only be charged with an appropriate DJI approved charger.

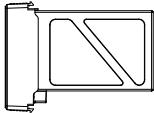

Intelligent Flight Battery

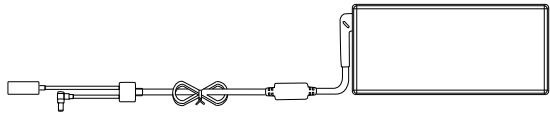

Charger

 The Intelligent Flight Battery must be fully charged before using it for the first time. Refer to [Charging the Intelligent Flight Battery \(P27\)](#) for more information.

DJI Intelligent Flight Battery Functions

1. Battery Level Display: LEDs display the current battery level.
2. Battery Life Display: LEDs display the current battery life.
3. Auto-discharging Function: The battery automatically discharges to below 65% of total power when it is left idle (pressing the power button will cause the battery to exit idle state) for more than 10 days to prevent swelling. It takes about two days to discharge the battery from 100% to 65%, and it is normal to feel moderate heat emitting from the battery during the discharge process. The discharge thresholds can be adjusted in the DJI GO app.
4. Balanced Charging: Automatically balances the voltage of each battery cell when charging.
5. Overcharge Protection: Automatically stops charging the battery when it is fully charged.
6. Temperature Detection: The battery will only charge when its temperature is between 0°C (32°F) and 40°C (104°F).
7. Overcurrent Protection: The battery stops charging when the maximum current of 10A is exceeded.
8. Over-Discharge Protection: The battery stops discharging when the battery voltage reaches 18V to prevent damage from over-discharge.
9. Short Circuit Protection: Automatically cuts the power supply when a short circuit is detected.
10. Battery Cell Damage Detection: The DJI GO app shows a warning message if a damaged battery cell is detected.
11. Battery Log: Show the last 32 entries of battery information including the warning messages.
12. Sleep Mode: The battery enters sleep mode after 10 minutes of inactivity to save power.
13. Communication: The battery voltage, capacity, current, and other relevant information is sent to the flight controller.

 Read the *Disclaimer and Safety Guidelines* and *Intelligent Flight Battery Safety Guidelines* before use. Users take full responsibility for all operations and usage.

Using the Battery

Installing the Battery

Insert the Intelligent Flight Battery into the battery compartment as shown below.

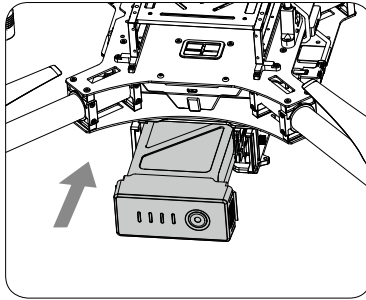

 Never insert the Intelligent Flight Battery into or remove it from the battery compartment of the Matrice 100 when it is powered on.

Powering On/Off the Battery

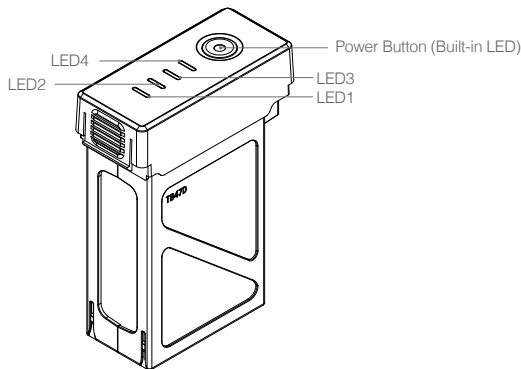

Powering On: Press the Power Button once, then press again and hold for 2 seconds to power on. The Power LED will turn red and the Battery Level Indicators will display the current battery level.

Powering Off: Press the Power Button once, then press again and hold for 2 seconds to power off.

Low Temperature Notice:

1. Using the Intelligent Flight Battery at core temperatures below -10°C is not advised. Between -10°C and 5°C , the Intelligent Flight Battery should attain a voltage of 4.2 V, but it is recommended that you apply the insulation sticker to the battery to prevent a rapid drop in temperature.
2. In cold environments (i.e. air temperature below 5°C), the performance of the Intelligent Flight Battery is reduced. Ensure the Intelligent Flight Battery is fully charged and attains a voltage of 4.35 V before takeoff.

3. In very cold environments (e.g. air temperature of -20°C, battery core temperature of 5°C), the Intelligent Flight Battery's core temperature will drop rapidly even after pre-heating, and its performance is significantly reduced. It is not recommended to fly under such conditions.
4. If the DJI GO app displays the Low Battery Level warning, stop flying and land the aircraft immediately. You will still be able to control the aircraft's movement when this warning is triggered.
5. For the optimal performance, maintain the Intelligent Flight Battery's core temperature above 20°C when in use.





































-
-  • Ensure the temperature of the Intelligent Flight Battery exceeds 5°C before takeoff.
- To warm up the battery, power on the Intelligent Flight Battery inside the battery compartment, for approximately 1-2 minutes, before takeoff. Begin flying by hovering the aircraft at a low altitude, for approximately 1 minute, to ensure the battery temperature is stable.
-

Checking the Battery Level

The Battery Level Indicator show how much battery capacity is remaining. When the battery is powered off, press the power button once. The Battery Level Indicator will light up to display the current battery level. See the table below for details.

 The Battery Level Indicator will show the current battery level during charging and discharging. Its LEDs can exhibit the following behavior.

-  : LED is on.
 -  : LED is blinking.
 -  : LED is off.
-

Battery Level Indicator				
LED1	LED2	LED3	LED4	Battery Level
				87.5%~100%
				75%~87.5%
				62.5%~75%
				50%~62.5%
				37.5%~50%
				25%~37.5%
				12.5%~25%
				0%~12.5%
				=0%

Checking the Battery Life

The battery life indicates the number of cycles the battery can be charged and discharged before it must be replaced. When the battery is powered off, press and hold the power button for 5 seconds to check the battery life. The Battery Level LEDs will light up and/or blink as described below for 2 seconds:

Battery Life				
LED1	LED2	LED3	LED4	Battery Life
□	□	□	□	90%~100%
□	□	□	▤	80%~90%
□	□	□	□	70%~80%
□	□	▤	□	60%~70%
□	□	□	□	50%~60%
□	▤	□	□	40%~50%
□	□	□	□	30%~40%
▤	□	□	□	20%~30%
□	□	□	□	below 20%

⚠ When the battery life reaches 0%, it can no longer be used.

📖 For more information about the battery, launch the DJI GO app and go to the Battery tab.

Charging the Intelligent Flight Battery

1. Connect the battery charger to a suitable power supply (100-240V 50/60Hz).
2. Open the protection cap and connect the Intelligent Flight Battery to the battery charger. If the battery level is above 95%, turn on the battery before charging.
3. The Battery Level Indicator will display the current battery level during charging.
4. The Intelligent Flight Battery is fully charged when Battery Level Indicators are all off. Disconnect the Intelligent Flight Battery from the battery charger.

- ⚠
- Do NOT charge the Intelligent Flight Battery and the remote controller (model: A14-100P1A) at the same time to avoid overloading the battery charger.
 - Air cool the Intelligent Flight Battery after each flight. Allow its temperature to drop to room temperature before charging.
 - The charging temperature range is 0 to 40°C. The battery management system will stop the battery from charging when the battery cell temperature is out of range.

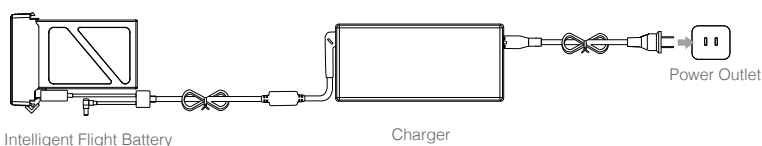

Battery Level Indicator While Charging				
LED1	LED2	LED3	LED4	Battery Level
				0%~25%
				25%~50%
				50%~75%
				75%~100%
				Fully charged

Charging Protection LED Display

The table below describes the battery protection mechanisms and their corresponding LED patterns.

Battery Level Indicator While Charging					
LED1	LED2	LED3	LED4	Indicators Pattern	Battery Protection Item
				LED2 blinks twice per second	Overcurrent detected
				LED2 blinks three times per second	Short circuit detected
				LED3 blinks twice per second	Overcharge detected
				LED3 blinks three times per second	Charger overvoltage detected
				LED4 blinks twice per second	Charging temperature is too low (<0°C)
				LED4 blinks three times per second	Charging temperature is too high (>40°C)

After any of the above protection issues are resolved, press the power button to turn off the Battery Level Indicator. Unplug the Intelligent Flight Battery from the battery charger and plug it back in to resume charging. Note that you do not need to unplug and plug the battery charger in the event of a room temperature error; the battery charger will resume charging when the temperature falls within the normal range.



DJI does NOT take any responsibility for damage caused by third-party battery chargers.



Calibrating the Battery Capacity:

To effectively calibrate the capacity of the Intelligent Flight Battery, it is recommended to charge and discharge the battery thoroughly for every 10 charge-and-discharge cycles. Choose one of the following methods to discharge battery. After discharging the battery, fully charge the battery to finish the calibration.

Slow: Place the battery into the Matrice 100's battery compartment and power it on. Leave it on until there is less than 5% battery level, or until it can no longer be turned on. Check the battery level in the DJI GO app.

Fast: Fly the Matrice 100 outdoors until there is less than 5% battery level, or until the battery can no longer be turned on.

Using the Remote Controller

Remote Controller Profile

The remote controller integrates video downlink and aircraft control into one system. The combined system operates at 2.4 GHz with a maximum signal transmission range of 5 km. The device features a number of standard and customizable buttons that allow users to quickly access certain aircraft functions, such as taking and reviewing photos/videos, as well as controlling the gimbal motion. It is powered by a 2S rechargeable battery.

- Compliance Version: The remote controller is compliant with both CE and FCC regulations.
- Operating Mode: Control can be set to Mode 1, Mode 2, or a custom mode in the DJI GO app.
- Mode 1: The right stick serves as the throttle.
- Mode 2: The left stick serves as the throttle.

⚠ Do NOT operate more than 3 aircrafts within in the same area (size equivalent to a soccer field) to prevent transmission interference.

Preparing Remote Controller

Mounting the Mobile Device Holder:

1. Unfold the Mobile Device Holder ①. Remove the screw using the slotted screwdriver coming with the Matrice 100 ②.

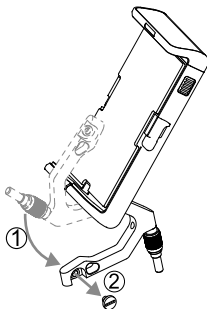

2. Plug the Mobile Device Holder into the remote controller and tighten the screw lock.
3. Line up the hole on the Mobile Device Holder with the metal loop on the remote controller. Insert and tighten the screw.

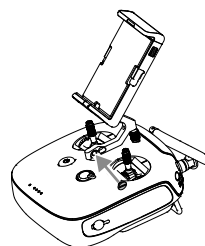
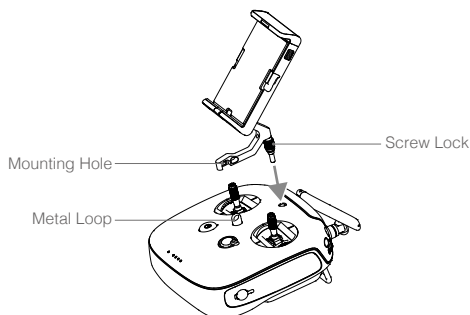

Tilt the Mobile Device Holder to the desired position and then adjust the antenna as shown. Follow the instructions below to connect your mobile device to the remote controller:

1. Press the button on the side of the Mobile Device Holder to release the clamp.
2. Place your mobile device inside the clamp and adjust it to secure your mobile device.
3. Connect your mobile device to the remote controller via a USB cable.

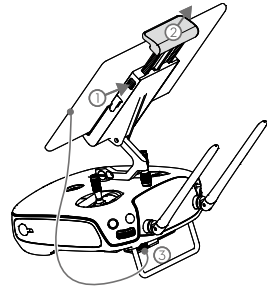
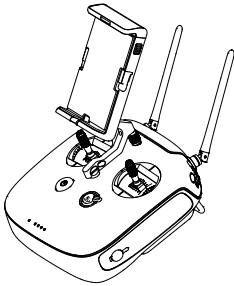

Remote Controller Diagram

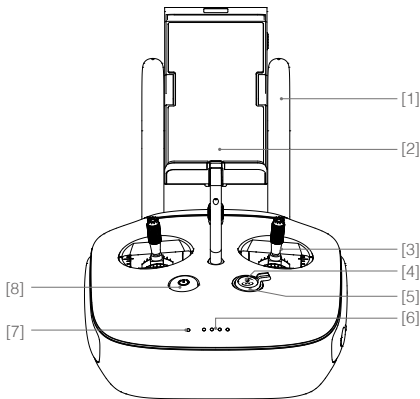

- [1] **Antennas**
Relays the aircraft control and video signals.
- [2] **Mobile Device Holder**
Mounting place for your mobile device.

- [3] **Control Stick**
Controls the aircraft movement.
- [4] **Return-to-Home (RTH) Button**
Press and hold this button to initiate Return-to-Home (RTH).
- [5] **RTH LED**
Circular LED around the RTH button which displays the RTH status.
- [6] **Battery Level LEDs**
Display the current battery level.
- [7] **Status LED**
Indicates whether the remote controller is linked to the aircraft.
- [8] **Power Button**
Used to power on/off the remote controller.

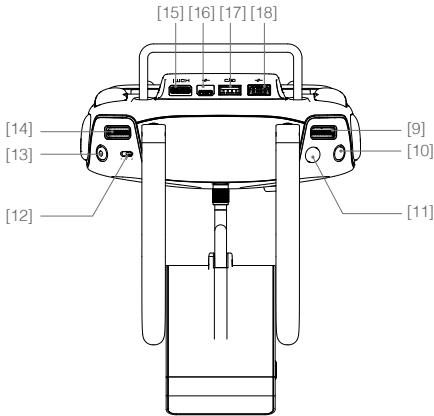

[9] Camera Settings Dial

Turn the dial to adjust the camera settings. Only functions when the remote controller is connected to a mobile device running the DJI GO app.

[10] Playback Button

Play back the captured images or videos.

[11] Shutter Button

Press to take a photo. If in burst mode, the

preset number of photos will be taken with one press.

[12] Flight Mode Switch

Used to switch between P-Mode (Positioning), A-Mode (Attitude) and F-Mode (Function).

[13] Video Recording Button

Press to start recording video. Press again to stop recording.

[14] Gimbal Dial

Used to control the pitch of the gimbal.

[15] Micro USB Port

Reserved for future use.

[16] Mini-HDMI Port

Connect an HD compatible monitor to this port to get a live HD video preview of what the camera sees.

[17] CAN Bus Port

Reserved for future use.

[18] USB Port

Connects to your mobile device to access all of the DJI GO app controls and features.

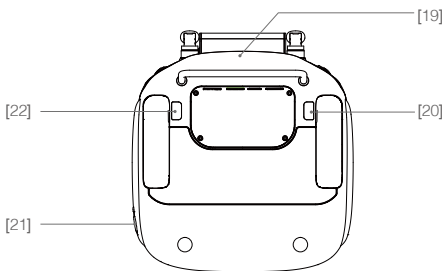

[19] GPS Module

Used to pinpoint the location of the remote controller.

[20] Back Left Button C1

Customizable button in the DJI GO app.

[21] Power Port

Connects to a power source to charge the remote controller's internal battery.

[22] Back Right Button C2

Customizable button in the DJI GO app.

Remote Controller Operation

Powering On and Off the Remote Controller

The Matrice 100 remote controller is powered by a 2S rechargeable battery with a capacity of 6000mAh. The battery level is indicated by the Battery Level LEDs on the front panel. Follow the steps below to power on/off your remote controller:

1. Press the power button once. The Battery Level LEDs will display the current battery level.
2. Press again and hold to power on the remote controller.
3. The remote controller will beep when it powers on. The Status LED will blink green rapidly, indicating that the remote controller is linking to the aircraft, then turn solid green when linking is complete.
4. Press twice and hold the power button to power off the remote controller.

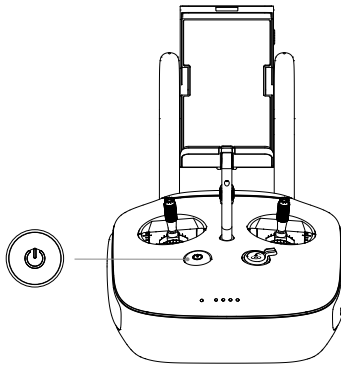

Charging the Remote Controller

Charge the remote controller via the provided charger.

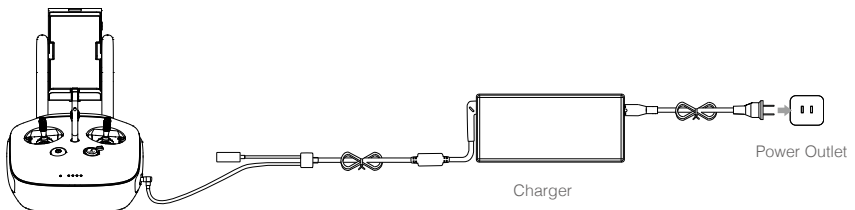

Controlling the Camera

Shoot videos or images and adjust the camera settings via the Shutter Button, Camera Settings Dial, Playback Button and Video Recording Button on the remote controller.

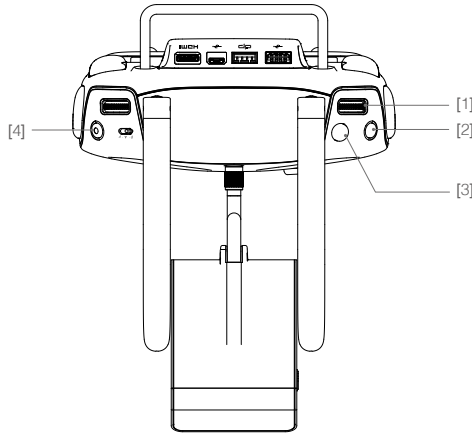

[1] Camera Settings Dial

Turn the dial to quickly adjust camera settings such as ISO and shutter speed without letting go of the remote controller. In Playback Mode, the dial button can be used to review the images or videos.

[2] Playback Button

Press to view images or videos that have already been captured.

[3] Shutter Button





Press to take a photo. If burst mode is activated, multiple photos will be taken with a single press.

[4] Recording Button

Press once to start recording video, then press again to stop recording.

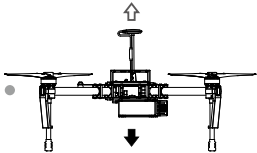
Controlling the Aircraft

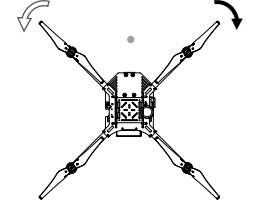
This section explains how to use the various features of the remote controller. Mode 2 (throttle stick on the left) is set by default.

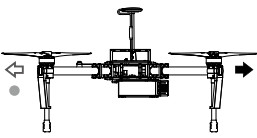
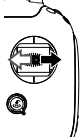
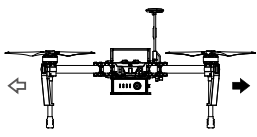
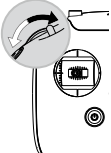
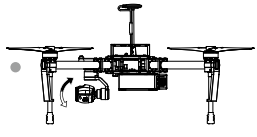

Remote Controller (Mode 2)	Aircraft (● indicates nose direction)	Function
		<p>Moving the Left Stick up/down changes the aircraft's elevation. Push it up to ascend and down to descend.</p> <p>Use this stick to take off when the motors are spinning at idle speed. The aircraft will hover in place if the Left Stick is released.</p>
		<p>Moving the Left Stick left/right changes the heading of the aircraft. Push it left to rotate the aircraft counter clock-wise, and right to rotate the aircraft clockwise.</p>
		<p>Moving the Right Stick up/down changes the aircraft's forward and backward pitch. Push it up to fly forwards and down to fly backwards.</p> <p>Push the Right Stick further for a larger pitch angle (max 35°) and faster flight.</p>
		<p>Moving the Right Stick left/right changes the aircraft's left and right pitch. Push it left to fly left and right to fly right.</p> <p>Push the Right Stick further for a larger pitch angle (max 35°) and faster flight.</p>
		<p>Turn the Gimbal Dial to the right to point the camera upwards, and to the left to point it downwards.</p>

 Always push the control sticks gently to prevent sudden and unexpected movement of the aircraft.

Flight Mode Switch

Toggle the switch to select the desired flight mode.

You may choose between P-Mode, A-Mode and F-Mode.

Figure	Flight Mode
	P-Mode
	A-Mode
	F-Mode

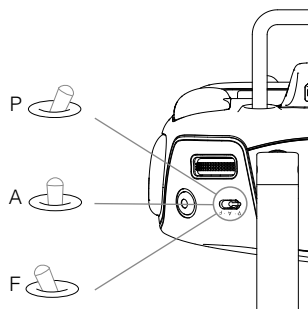

P-Mode (Positioning): P-Mode works best when GPS signal is strong. There are several states in P-Mode which are automatically selected by the Matrice 100 depending on GPS signal strength:

P-GPS: GPS is available. The aircraft uses GPS for positioning.

P-ATTI: GPS is not available. The aircraft only uses its barometer for maintaining altitude.

P-OPTI: GPS is not available. The aircraft uses the DJI Guidance* system for positioning.

If you have the DJI Guidance* system installed on your aircraft, be sure to enable the Obstacle Sensing Mode in the DJI Guidance Assistant and the DJI GO app (Enter Camera View >  > Guidance). The obstacle sensing function will be active in the P-GPS and P-OPTI states.

*Read the *Guidance User Manual* carefully before using the DJI Guidance system.

A-Mode (Attitude): GPS is not used for positioning. The aircraft only uses its barometer to maintain altitude. If it is still receiving a GPS signal, the aircraft will automatically Return-To-Home if the Remote Controller signal is lost, and if the Home Point was recorded successfully.

F-Mode (Function): Intelligent Orientation Control (IOC), API Control, and other functions are supported in this mode. Refer to the [IOC \(P64\)](#) section in the Appendix and Basic Page in [Using the PC Assistant \(P49\)](#) for more information.

The Flight Mode Switch is locked in P-Mode by default. To enable other flight modes, go to the DJI GO app > Camera View >  > Advanced Settings > Enable Multiple Flight Mode.

RTH Button

Press and hold this button to start the Return-to-Home (RTH) procedure. The LED around the RTH Button will blink white to indicate the aircraft is entering RTH mode. The aircraft will then return to the last recorded Home Point. Press this button again to cancel the RTH procedure and regain the control of the aircraft.

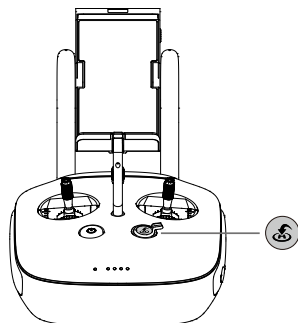

Connecting Your Mobile Device

Tilt the Mobile Device Holder to the desired position, then press the button on the side to release the clamp. Place your mobile device inside the clamp and adjust it to secure your mobile device. Now connect your mobile device to the remote controller with a USB cable.

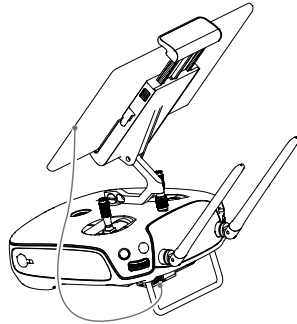

Optimal Transmission Range

The signal transmission between the aircraft and the remote controller performs best when the aircraft is within the optimal transmission range. Open up the antennas on the remote controller to optimize transmission range. Ideally, the flat surface of the antenna should be facing the aircraft. If the signal is weak, fly the aircraft closer to you.



Dual Remote Controllers Mode

More than one remote controller can be connected to the same aircraft in the Dual Remote Controllers mode. When using the DJI Zenmuse X3 Gimbal and Camera in the Dual Remote Controllers mode, the Master remote controller controls the movement of the aircraft, while the Slave remote controller controls the movement of the gimbal and camera. When multiple Slave remote controllers (max 6) are connected to the aircraft, only the first connected Slave remote controller is able to control the gimbal. The remaining Slave remote controllers can view the live feed video from the aircraft and set the camera parameters, but cannot control the gimbal.

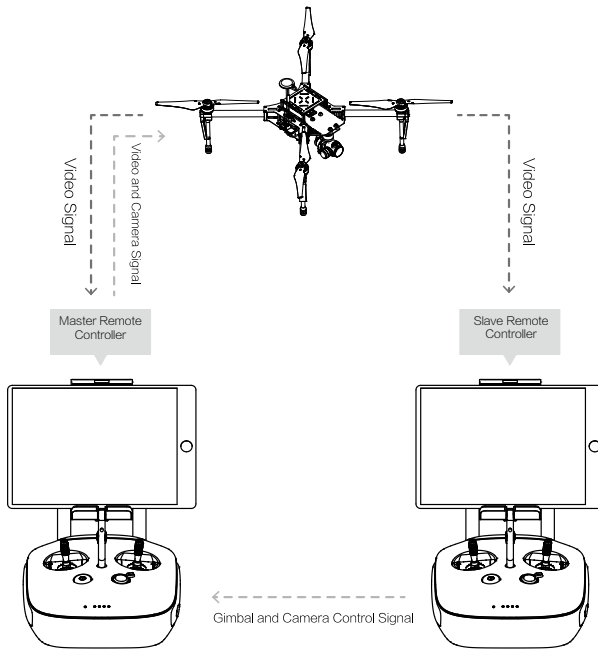

 Use the gimbal dial on the remote controller to tilt the camera in the Single Remote Controller mode. However, you cannot pan the camera.

Setting Up Dual Remote Controllers Mode

The Dual Remote Controllers mode is disabled by default. Users must enable this feature on the Master Remote Controller through the DJI GO app. Follow the steps below for setup:

Master Remote Controller:

1. Connect the remote controller to your mobile device and launch the DJI GO app.
2. Go to the Camera View, and tap  to enter the remote controller settings window.
3. Select Master in the Set RC Status section to set the remote controller as the Master remote controller.

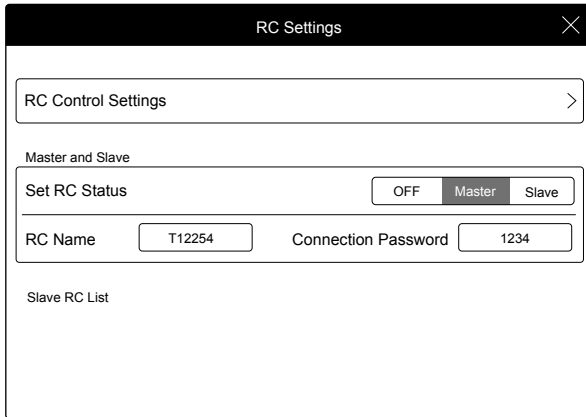

The screenshot shows the 'RC Settings' window. At the top is a black header with 'RC Settings' and a close button. Below is a white area with a 'RC Control Settings' button and a right arrow. Underneath is the 'Master and Slave' section, which includes a 'Set RC Status' label and three buttons: 'OFF', 'Master', and 'Slave'. Below this are two input fields: 'RC Name' with the value 'T12254' and 'Connection Password' with the value '1234'. At the bottom of this section is the label 'Slave RC List'.

4. Enter the connection password for the Slave remote controller.

Slave Remote Controller:

1. Select Slave in the Set RC Status section to set the remote controller as the Slave remote controller.

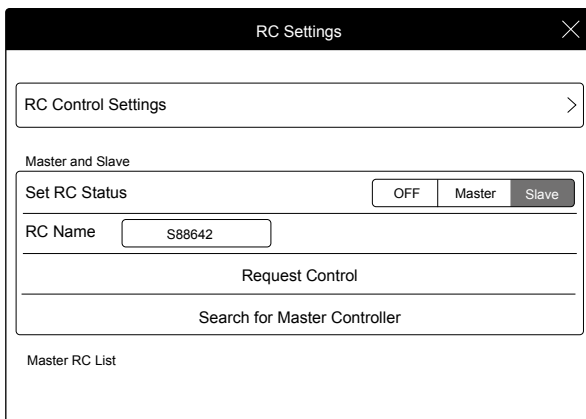

The screenshot shows the 'RC Settings' window. At the top is a black header with 'RC Settings' and a close button. Below is a white area with a 'RC Control Settings' button and a right arrow. Underneath is the 'Master and Slave' section, which includes a 'Set RC Status' label and three buttons: 'OFF', 'Master', and 'Slave'. Below this is an 'RC Name' input field with the value 'S88642'. A horizontal line separates this from the 'Request Control' section, which contains a 'Search for Master Controller' button. At the bottom of this section is the label 'Master RC List'.

2. Tap Search for Master Controller to register the Master remote controller.

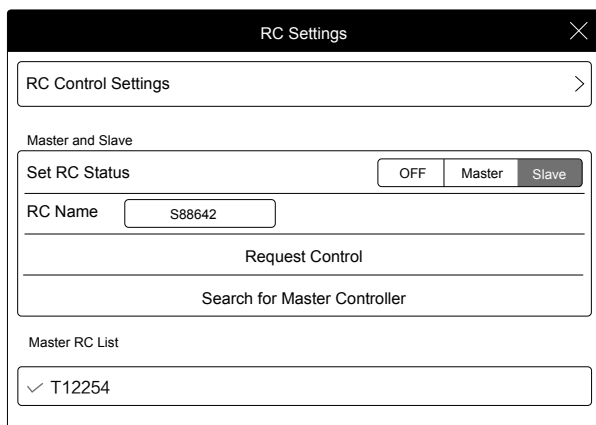

3. Select the name of the remote controller from the Master RC List and input the connection password to connect to the desired Master remote controller.

✓ T12254

Connection Password









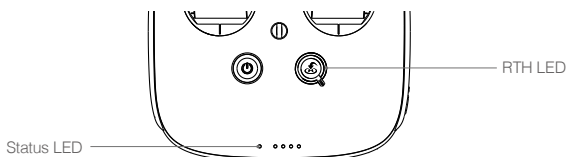



1234

⚠ The remote controller cannot link to the aircraft or control aircraft movement if it is set to Slave. Set the remote controller as Master in the DJI GO app if you want to link the remote controller to the aircraft.

Remote Controller Status LED

The Status LED indicates the connection status between the remote controller and the aircraft. The RTH LED indicates the Return-to-Home status of the aircraft. See the table below for details on these indicators.



Status LED	Alarm	Remote Controller Status
 — Solid Red	 chime	The remote controller is set as Master but is not connected to the aircraft.
 — Solid Green	 chime	The remote controller is set as Master and connected to the aircraft.
 — Solid Purple	D-D-	The remote controller is set as Slave but is not connected to the aircraft.
 — Solid Blue	D-D- 	The remote controller is set as Slave and connected to the aircraft.
 Blinking Red Slowly	D-D-D.....	Remote controller error.
 Red and Green/ Red and Yellow Alternate Blinks	None	HD Downlink is disrupted.
RTH LED	Sound	Aircraft Status
 — Solid White	 chime	Return-to-Home procedure is activated.
 Blinking White	D . . .	Sending Return-to-Home command to the aircraft.
 Blinking White	DD	Return-to-Home is in progress.

 When the battery level is critically low, the Remote Controller Status LED will blink red and sound an alert.

Linking the Remote Controller

The remote controller is linked to your aircraft by default. Linking is only required when a new remote controller is used for the first time. Follow these steps to link a new remote controller:

1. Power on the remote controller and connect it to your mobile device.
2. Power on the Intelligent Flight Battery.
3. Launch the DJI GO app. Go to the DJI GO app > Camera View >  ||| > RC Control Settings > Linking RC.

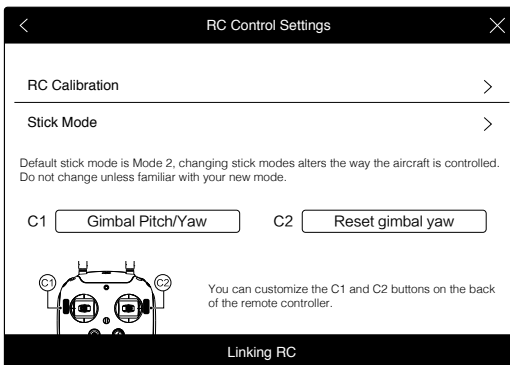

4. The Remote Controller Status LED will blink blue and emit a 'beep' sound to indicate that the remote controller is ready to be linked.

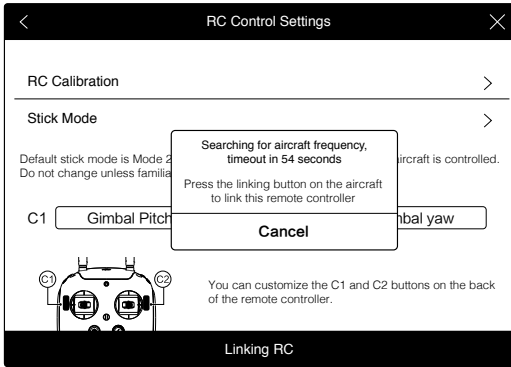

5. Press the red Linking Button besides the flight controller (shown in the figure) to begin linking. The Remote Controller Status LED will glow solid green if linking is successful.

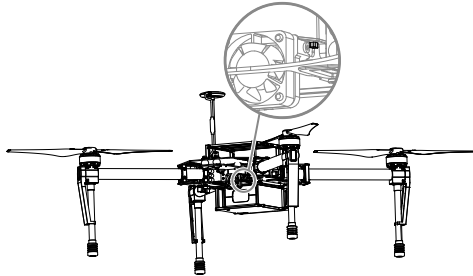

-  • The remote controller cannot link to the aircraft or control aircraft movement if it is set to Slave. Set the remote controller as Master in the DJI GO app if you want to link the remote controller to the aircraft.
- The remote controller will disconnect from the linked aircraft if another remote controller attempts to link to the same aircraft.



Remote Controller Compliance

The remote controller is compliant with CE and FCC standards.

Return-to-Home (RTH) and Dynamic Home Point

Return-to-Home (RTH)

The Return-to-Home (RTH) function brings the aircraft back to the last recorded Home Point. There are three events that will trigger RTH procedure: Smart RTH, Low Battery RTH and Failsafe RTH.

	GPS	Description
Home Point		The Home Point is the location at which your aircraft takes off when the GPS signal is strong. You can view the GPS signal strength through the GPS icon(). If you are using the Dynamic Home Point setting, the Home Point will be updated to your current position as you move around and when the Aircraft Status Indicator flashes green.

Smart RTH

Use the RTH button on the remote controller (see [RTH Button on P35](#) for more details) or the RTH button in the DJI GO app when GPS is available to enable Smart RTH. With Smart RTH, you may control the aircraft’s orientation to avoid collision when it is returning to the Home Point. Press the Smart RTH button once to start the RTH procedure, then press the Smart RTH button again to exit Smart RTH and regain control of the aircraft.

Low Battery RTH

Low Battery RTH is triggered when the DJI Intelligent Flight Battery is depleted to a point which may affect the safe return of the aircraft. Users are advised to fly back or land the aircraft immediately when these warnings are shown. The DJI GO app will advise users to return the aircraft to the Home Point when the low battery warning is triggered. The aircraft will automatically return to the Home Point if no action is taken after 10 seconds. User can cancel the RTH procedure by pressing on the RTH button once. The thresholds for these warnings are automatically determined based on the current aircraft altitude and its distance from the Home Point.

The aircraft will land automatically (cannot be canceled) if the current battery level can only support the aircraft to land to the ground from its current position. Users can use the remote controller to control the aircraft’s movement during the landing process.

The figure below describes the behavior of the Battery Level Indicator during different stages of events.

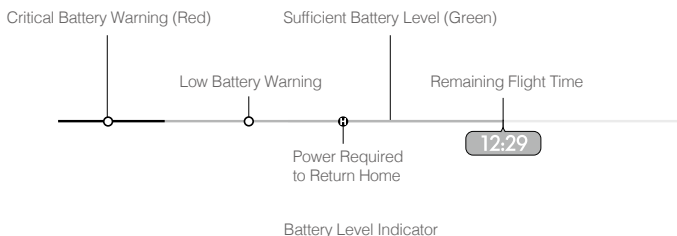

Battery Level	Description	Aircraft Status Indicator	DJI GO App	Flight Instructions
Low Battery Warning	The battery level is low. Please land the aircraft.	Aircraft Status Indicator flashes RED slowly.	Tap Go-Home to make the aircraft return to Home Point and land automatically, or Cancel to resume normal flight. If no action is taken, the aircraft will automatically return to the Home Point and land after 10 seconds.	Fly the aircraft back and land it as soon as possible, then stop the motors and replace the battery.
Critical Battery Warning	The aircraft must land immediately.	Aircraft Status Indicator flashes RED quickly.	The DJI GO app screen will flash red and the aircraft will begin to descend.	The aircraft will begin to descend and land automatically.
Remaining Flight Time	Estimated remaining flight time based on the current battery level.	N/A	N/A	N/A

- ☀️ When the critically low battery level warning is triggered and the aircraft is descending to land automatically, you may push the throttle stick upwards to hover the aircraft and navigate it to a more appropriate location for landing.
- Color zones and markers on the battery level indicator reflect the estimated remaining flight time and are adjusted automatically, according to the aircraft's current status.

Failsafe RTH

Failsafe RTH is activated automatically if the remote controller signal (including video relay signal) is lost for more than 3 seconds provided that the Home Point has been successfully recorded and the compass is working normally. The operator can interrupt the Return-to-Home procedure and regain control over the aircraft if the remote controller signal is recovered.

Failsafe Illustration

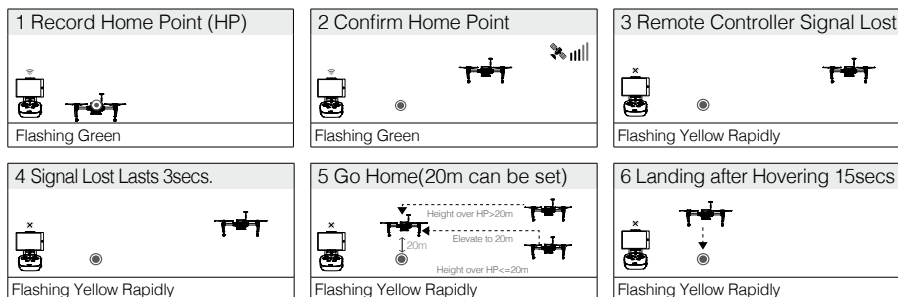

-
- ⚠ • The aircraft automatically descends and lands if RTH is triggered when the aircraft flies within a 65 feet (20 meter) radius of the Home Point.
 - The aircraft cannot avoid obstruction during Failsafe RTH, therefore it is important to set a reasonable Failsafe altitude before each flight. Go to the DJI GO app > Camera View >  > Advanced Settings > Failsafe Mode > Set Return-to-Home Altitude.
 - The aircraft will stop ascending and immediately return to the Home Point if you move the throttle stick during Failsafe RTH.
-

Dynamic Home Point



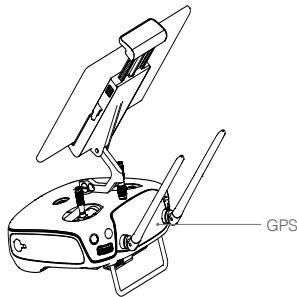

Dynamic Home Point is useful in situations when the operator is in motion and requires a Home Point that is different from the takeoff point. There are two options for Dynamic Home Point:

1. Set the aircraft's current coordinates as the Home Point.
2. Set the remote controller's current coordinates as the Home Point.



-
- ⚠ Ensure the space above the GPS module (shown above) is not obstructed when using Dynamic Home Point.
-

Follow the instructions below to use Dynamic Home Point:

1. Connect your mobile device to the remote controller and go to the DJI GO app > Camera View.
2. Tap  >  to set the remote controller's current coordinates as the Home Point; tap  >  to set the aircraft's current coordinates as the Home Point.
3. The Aircraft Status Indicator will flash green to indicate that the new Home Point has been set successfully.

DJI GO App

Use this app to control the gimbal, camera and other features of your flight system. The app also comes with the Director, Store, and User Center sections to configure your aircraft and share your content with friends. It is recommended that you use a tablet for the best user experience.

⚠ When connecting to the aircraft for the first time, ensure your mobile device is connected to the internet and follow the instructions to configure the basic settings for your aircraft.

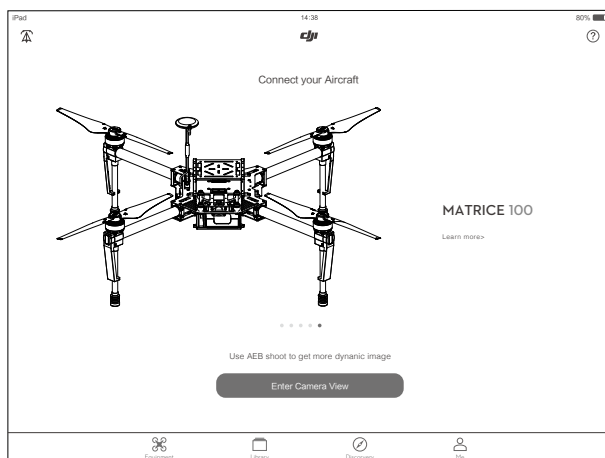

Equipment

On the Equipment page, you can enter Camera View, visit the Academy or view your flight records.

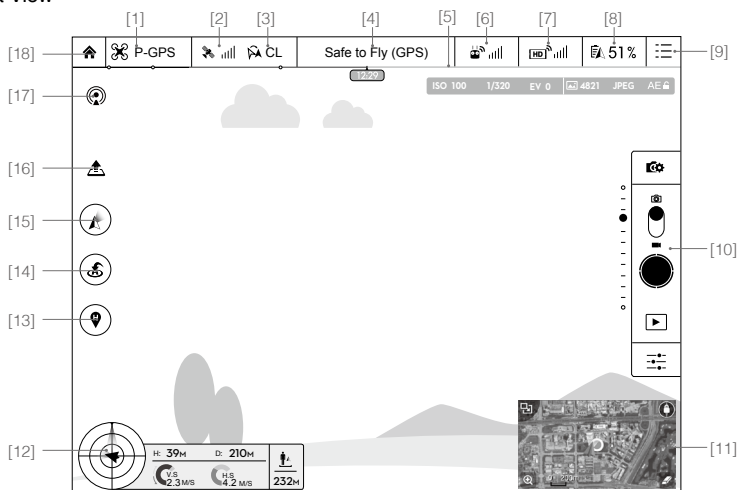

Camera View



[1] Flight Mode

: The text next to this icon indicates the current flight mode.

Tap this icon to configure the MC (Main Controller) Settings, to change the flight limits and set the gain values.

: When using the DJI GO app for the first time, the aircraft is in Beginner Mode. In this mode, the flight altitude and flight distance are set to 30 m. Tap  to exit Beginner Mode.

[2] GPS Signal Strength

: Shows the current GPS signal strength. Green bars indicate adequate GPS strength.

[3] IOC Settings

 CL: Displays the IOC settings when the aircraft has entered F-Mode. Tap this icon to view the IOC menu and select the desired IOC mode.

[4] System Status

 Safe to Fly (GPS) : Indicates the current aircraft system status and GPS signal strength.

[5] Battery Level Indicator

: Describes the battery level of the aircraft according to its immediate status. The colored zones represent the various stages of battery level. When the battery level drops to a certain stage, the system will prompt the user to take the appropriate action.

[6] Remote Controller Signal

: Shows the signal strength of the remote controller.

[7] HD Video Link Signal Strength

: Shows the signal strength of the HD video downlink between the aircraft and the remote controller.

[8] Battery Level

 51% : Shows the current battery level.

Tap this icon to view the battery information menu where you can set the battery warning thresholds and view the battery log.

[9] General Settings

: Tap this icon to view General Settings where you can set the flight parameters, reset the camera settings, enable the Quick Review function, adjust the Gimbal Roll value, and enable the Flight Route display.

[10] Camera Operation Bar**Shutter and Recording Settings**

: Tap this icon to enter various camera value settings including the Color mode, Video Size, and Image Size.

Shutter

: Tap this button to take a single photo. Press and hold this button to switch between Single Shot, Triple Shot and Timed Shot modes.

Record

 : Tap once to start recording video, then tap again to stop recording. You can also press the Video Recording Button on the remote controller.

Playback

 : Tap this icon to play back photos and videos after they are captured.

Camera Settings

 : Tap this icon to set the ISO, Shutter Speed and Exposure Value of the camera.

[11] Mini Map

Displays the flight path of the current flight. Tap the Mini Map to switch between Camera View and Map View.



[12] Flight Telemetry

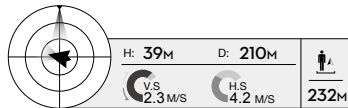

Flight Attitude and Radar Function:

The aircraft's flight attitude is indicated by the target-like icon.

- (1) The red arrow shows which direction the aircraft is facing.
- (2) The ratio of the grey area to the blue area indicates the aircraft's pitch.
- (3) The horizontal level of the grey area indicates the aircraft's roll angle.

Flight Parameters:

Altitude: Vertical distance from the Home Point.

Distance: Horizontal distance from the Home Point.

Vertical Speed: Movement speed across a vertical distance.

Horizontal Speed: Movement speed across a horizontal distance.

Aircraft Distance:

The horizontal distance between the aircraft and the operator.

[13] Home Point Settings

 : Tap this icon to update the Home Point. You may set the aircraft takeoff location, the remote controller's current position, or the aircraft's current position as the Home Point.



[14] Return-to-Home (RTH)

 : Tap this icon to initiate the RTH procedure which will bring the aircraft back to the latest Home Point.

[15] Gimbal Operation Mode

Refer to DJI Zenmuse X3 Gimbal and Camera under the [Appendix \(P73\)](#) for more information.

[16] Auto Takeoff/Landing

 /  : Tap to initiate auto takeoff or landing.

[17] Livestream

 : This icon indicates the current video feed is being broadcast live on YouTube. Ensure that mobile data service is available on your mobile device.

[18] Back

 : Tap this icon to return to the main menu.

Library

Director is an intelligent video editor built into the DJI GO app. After recording several video clips and downloading them to your mobile device, go to Director on the home screen. You can then select a template and a specified number of clips which are automatically combined to create a short film that can be shared immediately.

Explore

Find out about our latest events, featured products and trending Skypixel uploads in the Explore page.

Me

If you already have a DJI account, you will be able to participate in forum discussions, earn Credits in the DJI Store, and share your artwork with the community.

Using the PC Assistant

- Go to the Matrice 100 product page and download:
 - DJI Assistant 2 package
 - DJI WIN driver (if you use Windows 7 or 8)
<http://www.dji.com/product/matrice100/info#downloads>
- Extract the DJI Assistant 2 package to the desired directory. No installation is required.
- Install the DJI WIN driver if needed.

 DJI Assistant 2 supports Windows 7 (or later) or Mac OS X 10.9 (or later).

- Launch DJI Assistant 2.
- Connect the Matrice 100 to your PC with a Micro USB cable. Turn on the remote controller and the aircraft. Do not disconnect the cable until configuration is complete.

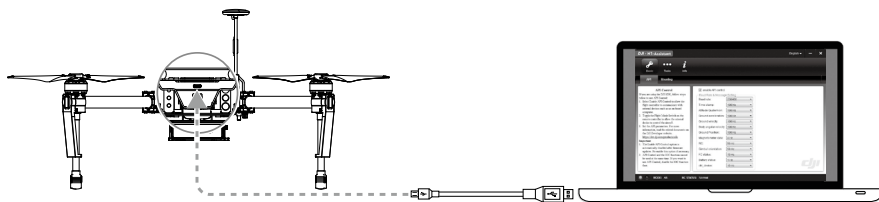

- Choose "M100" from the list of connected devices and sign in with your DJI account.

Basic Setup

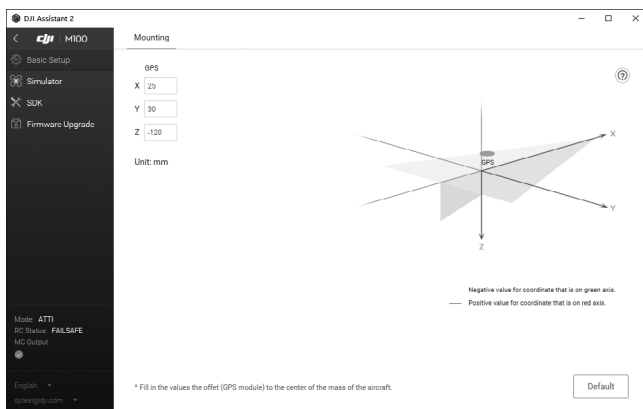

Fill in the coordinates of the GPS module relative to the aircraft's geometric center (GC). The aircraft's GC can be approximated as the intersection of lines joining opposite motors, at the same level as the propeller rotation plane. Note the negative and positive directions of the X, Y and Z axes illustrated in the application. Leave the IMU coordinates as the default values.

- ⚠ Inaccurate coordinates or a wrong axis polarity may cause the aircraft to vibrate during flight. If this happens, double check the configuration parameters.
- The label on the GPS module should face upwards, and the arrow should point to the nose of the aircraft.
- Be sure to update the settings if you change the mounting positions of your aircraft's components.

Simulator

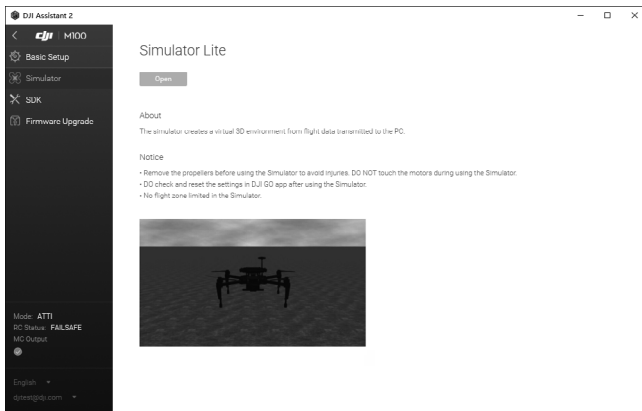

The simulator creates a virtual 3D environment from flight data transmitted to the PC via the WebSocket interface.

SDK



If you are using the DJI SDK, select “Enable API Control” to allow the flight control system to communicate with external devices such as an onboard computer. The external device will be able to control the aircraft only if the flight mode switch on the remote controller is toggled to F-mode. For information on setting the API parameters, read the related documents and manuals on the DJI SDK page of the DJI Developer website (<https://developer.dji.com>).

- ⚠ • API Control and the IOC function cannot be used at the same time. If you want to use API Control, disable the IOC function first.
- The Enable API Control option is automatically disabled after firmware upgrades. Re-enable this option if necessary.

Firmware Upgrade

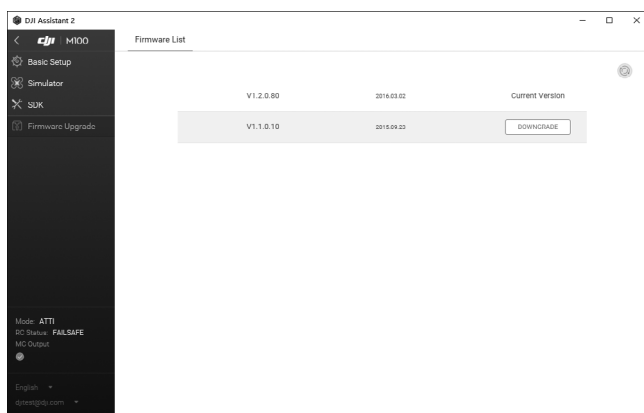

Choose the desired firmware version from the firmware list and click “Upgrade”. After reading the popup notice, click “Start Upgrade”. The text “Upgrade Successful!” will be displayed when the upgrade is complete. If the upgrade fails, try again or contact DJI Support.

Upgrade the firmware of the extra Intelligent Flight Battery as follows:

- a. Remove the upgraded battery from the aircraft.
- b. Insert the extra battery, powered off, into the battery compartment connected to the flight controller.
- c. Turn on the Intelligent Flight Batteries. Click the Upgrade button to upgrade the firmware.

Upgrade the remote controller firmware via the DJI GO app. Refer to “Upgrading the Firmware (P63)” for details.

- ⚠ • The remote controller may become unlinked from the aircraft after the firmware upgrade. Relink the remote controller to the aircraft if necessary.
- It is normal for the aircraft to make sounds or its LEDs to flash during the firmware upgrade.
- If you are using the DJI Zenmuse X3 or X5 series gimbal and camera or the DJI N1 Video Encoder, upgrade all firmware using the firmware update package. Refer to Upgrading the Firmware (P63) for details.

Using the SDK

DJI Mobile API and Onboard API are supported by the Matrice 100. Users can use these APIs to develop their own applications to monitor and control their aircraft. Visit the DJI SDK page on the DJI Developer website (<https://developer.dji.com>) for information on using these APIs.

Flight

Once pre-flight preparation is complete, it is recommended to use the flight simulator to learn how to fly safely. Ensure that all flights are carried out in an open area.

Flight Environment

1. Do not use the aircraft in adverse weather conditions including raining, snowing, fog, and wind speeds exceeding 10 m/s.
2. Only fly in open areas. Tall buildings and steel structures may affect the accuracy of the compass and the GPS signal.
3. Avoid flying near obstacles, crowds, high voltage power lines, trees and bodies of water.
4. Avoid flying in area with high levels of electromagnetism, including mobile phone base stations and radio transmission towers.
5. Aircraft and battery performance is subject to environment factor such as air density and temperature. Be very careful when flying over 14700 feet (4500 meters) above sea level as the battery and aircraft performance may be reduced.
6. The Matrice 100 cannot operate in P-Mode within the Earth's polar regions.

Flight Limits and No Fly Zones

Flight limits on height and distance can be set.



Unmanned aerial vehicle (UAV) operators should abide by the regulations from self-regulatory organizations such as the ICAO (International Civil Aviation Organization), the FAA and their local aviation authorities. For safety reasons, flight limits are enabled by default to help users use this product safely and legally.

When operating in P-Mode, the height limit, distance limit and No Fly Zones work together to monitor flight. In A-Mode, only the height limit prevents the aircraft from going above 120 meters.

Maximum Height and Radius Limits

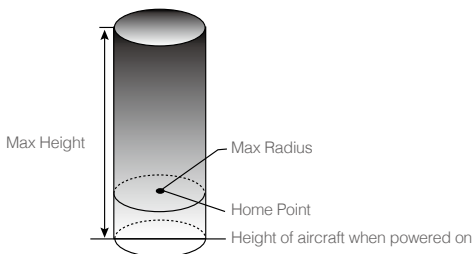
Users can change the maximum height and radius limits in the DJI GO app. Once complete, your Matrice 100 will fly in a restricted cylinder that is determined by these settings. The tables below show the details of these limits.



GPS Signal is Strong  Flashing Green			
	Flight Limits	DJI GO App	Aircraft Status Indicator
Max Height	Flight altitude must be below the preset height.	Warning: Height limit reached.	None.
Max Radius	Flight distance must be within the max radius.	Warning: Distance limit reached.	Flashes red rapidly when the aircraft approaches the max radius limit. 

GPS Signal is Weak  Flashing Yellow			
	Flight Limits	DJI GO App	Aircraft Status Indicator
Max Height	Flight height restricted to under 120m.	Warning: Height limit reached.	None.
Max Radius	No limit		

-  • If you fly out of bounds, you can still control the Matrice 100, but cannot fly it further.
 • If the Matrice 100 loses GPS signal and flies out of the max radius but regains GPS signal afterwards, it will fly back within range automatically.

No Fly Zones

All No Fly Zones are listed on the DJI official website at <http://flysafe.dji.com/no-fly>. No Fly Zones are divided into Airports and Restricted Areas. Airports include major airports and flying fields where manned aircraft operate at low altitudes. Restricted Areas include borders between countries or sensitive sites. The details of the No Fly Zones are explained below:

Airports (requires GPS):

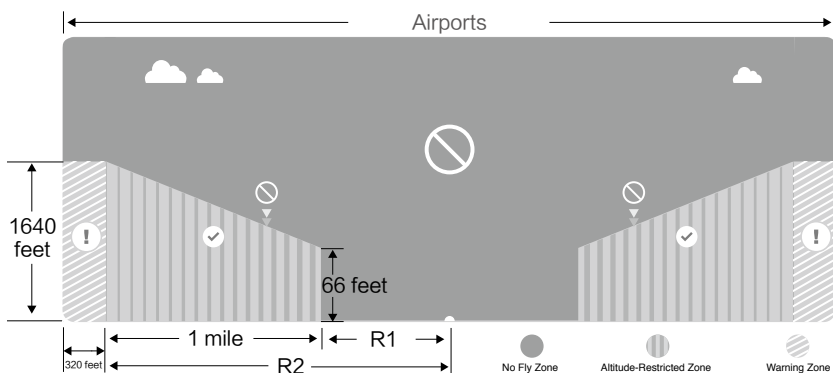





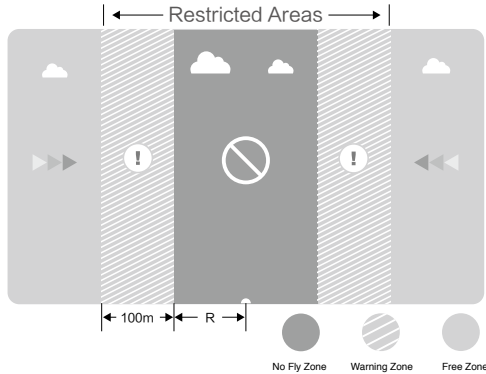

1. Airport No Fly Zones are comprised of a no fly zone and an altitude-restricted zone. Each type of zone encompasses a radius of a certain size.
2. R1 miles around the airport (depending on its shape and size) encompasses the no fly zone, inside of which takeoff and flight are prohibited.

3. From R1 to R1+1 miles around the airport, the flight altitude is limited at a 15 degree incline, starting at 66 feet (20 meters) from the edge of airport and radiating outwards. The flight altitude is limited to 1640 feet (500 meters) at R1+1 miles.
4. When the aircraft is within 320 feet (100 meters) of a no fly zone, a warning message will appear in the DJI GO app.

Restricted Areas (requires GPS):



1. Restricted Areas do not have an altitude-restricted zone.
2. R miles around the Restricted Area (depending on the regulation) is a no fly zone, inside of which takeoff and flight are prohibited.
3. A Warning Zone is set on the perimeter of the Restricted Area. When the aircraft is within 0.062 miles (100 m) of the no fly zone (inside the Warning Zone), a warning message will appear in the DJI GO app.

GPS Signal is Strong  Flashing Green			
Zone	Restrictions	DJI GO App Warning	Aircraft Status Indicator
No Fly Zone 	Motors will not start.	Warning: You are in a no fly zone. Takeoff prohibited.	
	If the aircraft loses GPS signal and enters the restricted area but regains GPS signal afterwards, the aircraft will enter Semi-Automatic Descent and land itself.	Warning: You are in a no fly zone. Automatic landing has begun. (If the aircraft is within R1)	
Altitude-Restricted Zone 	If the aircraft loses GPS signal and enters the restricted area but regains GPS signal afterwards, it will descend to a safe altitude and hover 15 feet below the safe altitude.	Warning: You are in a restricted zone. Descending to a safe altitude. (If the aircraft is within R2 but outside R1) Warning: You are in a restricted zone. Max flight height restricted between 20 and 120 m. Fly Cautiously.	 Flashing Red
Warning Zone 	No flight restrictions.	Warning: You are approaching a Restricted Area. Fly cautiously.	
Free Zone 	No flight restrictions.	None.	None.

 Semi-Automatic Descent: All stick commands are available except the throttle stick command during the descent and landing process. Motors will stop automatically after landing.

-  • When flying in No Fly Zones, the Aircraft Status Indicator will flash red rapidly and continue for 3 seconds, then switch to indicate the current flying status and continue for 5 seconds, at which point it will switch back to flashing red rapidly.
- For safety reasons, please do NOT fly close to airports, highways, railway stations, railway lines, city centers or other busy areas. Try to ensure the aircraft is visible at all times.

Pre-Flight Checklist

1. The remote controller, Intelligent Flight Battery, and your mobile device are fully charged.
2. Propellers are mounted correctly and firmly.
3. Motors start properly and are functioning as normal.
4. The DJI GO app is connected to the aircraft.

Flight Status Indicator

The Matrice 100 comes with Front LEDs, Rear LEDs and an Aircraft Status Indicator. The positions of these LEDs are shown in the figure below:

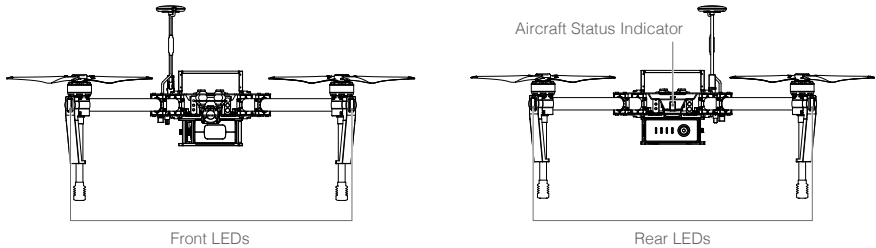

The Front and Rear LEDs show the orientation of the aircraft. The Front LED is red and the Rear LED is green. The Aircraft Status Indicator indicates the status of the flight controller. Refer to the table below for more information about the Aircraft Status Indicator:

Aircraft Status Indicator Description

Normal

..... Flashing Red, Green and Yellow Alternately	Power on and self-check
..... Flashing Green and Yellow Alternately	Aircraft warming up
..... Flashing Green Slowly	Safe to Fly (P-Mode with GPS)
..... Flashing Yellow Slowly	Safe to Fly (No GPS)
× 2 Flashing Green Twice at a Time	Safe to Fly (P-Mode with the DJI Guidance system but without GPS)
..... Flashing Blue Slowly (Alternates with Safe to Fly pattern)	The Obstacle Sensing Mode of the DJI Guidance system is enabled.

Warning

..... Flashing Yellow Rapidly	Remote controller signal Lost
..... Flashing Red Slowly	Low battery warning
..... Flashing Red Rapidly	Critically low battery warning
..... Flashing Red Alternately	IMU error
— Solid Red	Critical error
..... Flashing Red and Yellow Alternately	Compass calibration required
..... Flashing Purple Slowly	Guidance Sensor error. Land your aircraft and recalibrate the Guidance Sensors.

Calibrating the Compass

IMPORTANT: Be sure to calibrate the compass for every new flight location. The compass is a very sensitive instrument that requires regular calibration to ensure optimal flight performance. Abnormal compass data due to a lack of calibration can lead to poor flight performance or even failure.

- ⊘ • Do NOT calibrate your compass where there is a chance of strong magnetic interference, such as magnetite quarries, parking structures, and underground steel reinforcements.
- Do NOT carry ferromagnetic objects such as keys with you during calibration.
- Do NOT calibrate besides massive metal objects.
- Do NOT calibrate in an indoor space.

Calibration Procedures

Choose an open space to carry out the following procedures.

1. Ensure the compass is calibrated. If you did not calibrate the compass as part of your pre-flight preparations, or if you have moved to a new location since the last calibration, tap the System Status bar in the app and select Calibrate, then follow the on-screen instructions to calibrate the aircraft step-by-step.
2. Hold the aircraft horizontally, and rotate it 360 degrees along the central axis. The Aircraft Status Indicator will emit a solid green light.
3. Hold the aircraft vertically with its nose pointing downwards, and rotate it 360 degrees around its central axis.

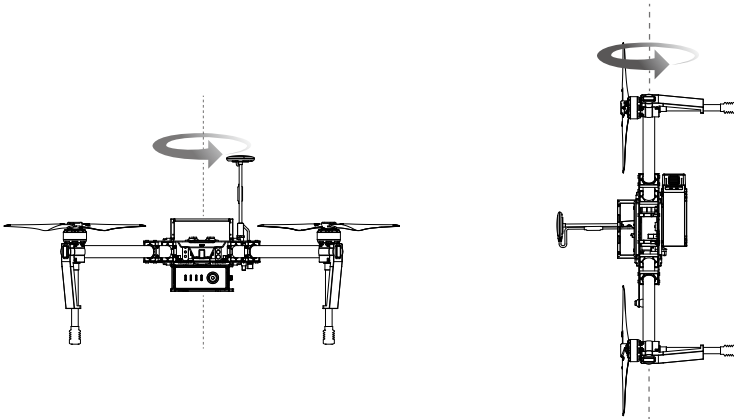

4. Recalibrate the compass if the Aircraft Status Indicator becomes solid red.

⚠ If the Aircraft Status Indicator flashes red and yellow alternatively after compass calibration, move your aircraft to a different location to carry out the calibration.

☀ Calibrate the compass after you launch the DJI GO app if you are prompted to do so.

When to Recalibrate

1. The compass data is abnormal, and the Aircraft Status Indicator is flashing red and yellow alternatively.

2. Flying in a new location, or a location that is different from your last flight.
3. The mechanical structure of the Matrice 100 is changed, i.e. the mounting position of the GPS module is changed.
4. Severe drifting occurs in flight, i.e. the Matrice 100 has difficulty flying in a straight line.

Auto Takeoff and Auto Landing

Auto Takeoff

Use Auto Takeoff to take off your aircraft automatically if the Aircraft Status Indicator is flashing green. Follow the steps below to use Auto Takeoff:

1. Launch the DJI GO app and enter the Camera View.
2. Ensure that the aircraft is in P-Mode.
3. Go through the pre-flight checklist.
4. Tap  and slide Confirm to take off.
5. The aircraft will take off and hover 1.2 meters above the ground.

Auto Landing

Use Auto Landing to land your aircraft automatically if the Aircraft Status Indicator is flashing green. Follow the steps below to use Auto Landing:

1. Ensure that the aircraft is in P-Mode.
2. Check that the landing area is clear before tapping  to land the aircraft.
3. The aircraft will begin to land automatically.

Starting and Stopping the Motors

The Combination Stick Command (CSC) listed below is used to start/stop the motors. Ensure you perform the CSC in one continuous motion.

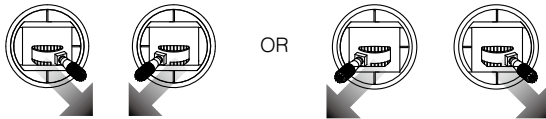

Starting the Motors

Perform the CSC command. The motors will begin to speed at an idle speed, with the aircraft remaining stationary.

Stopping the Motors

There are two methods to stop the motors.

Method 1: When the Matrice 100 has landed, push the throttle stick down, then perform the CSC command to stop the motors. Release both sticks once the motors have stopped.

Method 2: When the aircraft has landed, push the throttle down and hold. The motors will stop after 3 seconds.

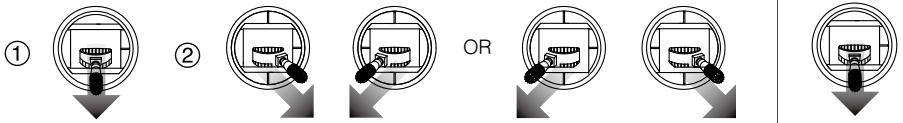

 Do NOT perform the CSC command when the aircraft is in mid-air.

Flight Test

Takeoff / Landing Procedures

1. Place the aircraft on an open, flat ground with the battery indicator facing you.
2. Power on the remote controller and your mobile device, and then the Intelligent Flight Battery.
3. Launch the DJI GO app and enter Camera View.
4. Wait until the Aircraft Status Indicator flashes green. This means the Home Point is recorded and it is safe to fly. If it flashes yellow, the Home Point has not been recorded and you should not take off.
5. Push the throttle stick up slowly to take off or use Auto Takeoff.
6. To land, hover over a level surface and gently pull down on the throttle stick to descend slowly.
7. After landing, execute the CSC command or push the throttle stick down for 3 seconds until the motors come to a stop.
8. Turn off the Intelligent Flight Battery, followed by the remote controller.

-
-  • When the Aircraft Status Indicator flashes yellow rapidly during flight, the aircraft has entered the Failsafe mode.
- The Aircraft Status Indicator will flash red slowly for a Low Battery Level warning, and flash red rapidly for a Critically Low Battery Level warning during flight.
-

Appendix

Product Specifications

Structure	
Diagonal Wheelbase	650 mm
Weight (with TB47D battery)	2355 g
Weight (with TB48D battery)	2431 g
Max Takeoff Weight	3600 g
Optional Accessories	
Expansion Bay Weight	45 g
Battery Compartment Weight	160 g
Zenmuse X3 Gimbal and Camera Weight	247 g
Performance	
Hovering Accuracy (P-Mode, with GPS)	Vertical: 0.5 m, Horizontal: 2.5 m
Max Angular Velocity	Pitch: 300°/s, Yaw: 150°/s
Max Pitch Angle	35°
Max Speed of Ascent	5 m/s
Max Speed of Descent	4 m/s
Max Wind Resistance	10 m/s
Max Speed	22 m/s (ATTI mode, no payload, no wind) 17 m/s (GPS mode, no payload, no wind)
Hovering Time (with TB47D battery)	No payload: 22 min; 500g payload: 17 min; 1kg payload: 13 min
Hovering Time (with TB48D battery)	No payload: 28 min; 500g payload: 20 min; 1kg payload: 16 min
Hovering Time (with two TB47D batteries)	No payload: 33 min
Hovering Time (with two TB48D batteries)	No payload: 40 min
Hovering Time (with TB47D battery and Zenmuse X3)	No payload: 19 min
Hovering Time (with TB48D battery and Zenmuse X3)	No payload: 23 min







* The hovering time is based on flying at 10m above sea level in a no-wind environment and landing with 10% battery level.

Propulsion System	
Motor Model	DJI 3510
Propeller Model	DJI 1345s
ESC Model	DJI E SERIES 620D
Flight Control System	
Model	N1
Other	
Operating Temperature	-10 to 40 °C
Remote Controller	
Name	C1
Operating Frequency	5.725~5.825 GHz 922.7MHz~927.7 MHz (Japan) 2.400~2.483 GHz (Lightbridge)
Max Transmission Distance (unobstructed, free of interference)	FCC Compliant: 3.1 miles (5 km) CE Compliant: 2.1 miles (3.5 km)
EIRP	10dBm@900M 13dBm@5.8G 20dBm@2.4G
Video Output	USB, Mini-HDMI
Power Supply	Built-in battery
Charger	DJI approved charger
Dual Users Capability	Master-and-Slave control
Mobile Device Holder	Supports smartphones and tablets
Output Power	9 W
Operating Temperature	-10 to 40 °C
Storage Temperature	< 3 months: -20 to 45 °C > 3 months: 22 to 28 °C
Charging Temperature	0 to 40 °C
Battery	6000 mAh LiPo 2S
Max Tablet Width	170 mm
Charger	
Model	A14-100P1A
Voltage Output	26.3 V
Power Rating	100 W
Battery (Standard)	
Name	Intelligent Flight Battery
Model	TB47D
Capacity	4500 mAh

Voltage	22.2 V
Type	LiPo 6S High voltage battery
Energy	99.9 Wh
Net Weight	600 g
Operating Temperature	-10 to 40 °C
Storage Temperature	< 3 months: -20 to 45 °C > 3 months: 22 to 28 °C
Charging Temperature	0 to 40 °C
Max Charging Power	180 W
Battery (Optional)	
Name	Intelligent Flight Battery
Model	TB48D
Capacity	5700 mAh
Voltage	22.8 V
Type	LiPo 6S
Energy	129.96 Wh
Net Weight	676 g
Operating Temperature	-10 to 40 °C
Storage Temperature	< 3 months: -20 to 45 °C > 3 months: 22 to 28 °C
Charging Temperature	0 to 40 °C
Max Charging Power	180 W







Aircraft Status Indicator Description

Normal

 Flashing Red, Green and Yellow Alternately	Power on and self-check
 Flashing Green and Yellow Alternately	Aircraft warming up
 Flashing Green Slowly	Safe to Fly (P-Mode with GPS)
 Flashing Yellow Slowly	Safe to Fly (No GPS)
 × 2 Flashing Green Twice at a Time	Safe to Fly (P-Mode with the DJI Guidance system but without GPS)
 Flashing Blue Slowly (Alternates with Safe to Fly pattern)	The Obstacle Sensing Mode of the DJI Guidance system is enabled.

Warning

 Flashing Yellow Rapidly	Remote controller signal Lost
--	-------------------------------

 Flashing Red Slowly	Low battery warning
 Flashing Red Rapidly	Critically low battery warning
 Flashing Red Alternately	IMU error
 — Solid Red	Critical error
 Flashing Red and Yellow Alternately	Compass calibration required
 Flashing Purple Slowly	Guidance Sensor error. Land your aircraft and recalibrate the Guidance Sensors.

Intelligent Orientation Control (IOC)



IOC allows users to lock the orientation of aircraft in different fashions. It has three working modes you can choose in the DJI GO app. IOC only works in F-Mode, and users must toggle the flight mode switch to F-Mode to activate IOC. The three work modes are:

CL	Lock the current nose direction as the aircraft's forward direction. The aircraft will move in the locked directions regardless of its orientation (yaw angle). Tap Reset IOC to reset the Course Lock.
HL*	Record a Home Point, and push the Pitch stick up/down to control the distance of the aircraft from the Home Point.
POI*	Record a point of interest (POI). The aircraft's nose always points towards the POI.

 *The Home Lock (HL) and Point of Interest (POI) features are coming soon.

Prerequisites of IOC

Use IOC under the following conditions:

IOC Modes	GPS Enabled	GPS Signal Strength	Flight Distance Limits
Course Lock	No	None	None
Home Lock	Yes		Aircraft $\leftarrow \geq 10\text{ m} \rightarrow$ Home Point
POI	Yes		Aircraft $\leftarrow 5\text{ m} - 500\text{ m} \rightarrow$ POI

Enabling IOC

Go to the DJI GO app > Camera View >  > Advanced Settings > Toggle IOC. On the remote controller, toggle the Flight Mode Switch to F-Mode to use IOC.



F-Mode supports IOC, API Control and other functions, with IOC having the highest priority. Disable IOC first to use other functions.

How to Upgrade the Firmware

Upgrading the Aircraft and Battery Firmware

If you are using the DJI Zenmuse X3 or X5 Series gimbal and camera:

Step 1 - Check the battery level and Micro SD card storage

- Make sure the Intelligent Flight Battery has at least a 50% charge.
- Make sure that the Micro SD card has 100MB of free space.

Step 2 - Prepare the firmware Update package

1. Download the firmware update package from the DJI official website.
(<http://www.dji.com/product/matrice100/info#downloads>)
2. Extract all files to the root directory of your Micro SD card.
3. With the aircraft powered off, insert your Micro SD card into the camera.

Step 3 - Run the upgrade

1. With the remote controller turned off, power on the aircraft. The firmware upgrade will begin automatically.
2. Wait about 25 minutes for the upgrade to complete. The aircraft will beep "D-D-D-D" while upgrading, and beep "D—DD" when the upgrade is complete.
3. Confirm the upgrade result by opening the ".txt" file generated in the root directory of your Micro SD card. You will see the text "result: successful" or "result: failed".

Step 4 - Upgrade any extra batteries

1. Remove the upgraded battery from the aircraft.
2. Insert the extra battery, powered off, into the battery compartment connected to the flight controller.
3. Power on the battery to start.

If you are NOT using the DJI Zenmuse X3 or X5 Series gimbal and camera:

Method 1 – Using the DJI Assistant 2

Connect the aircraft to DJI Assistant 2 to upgrade the firmware. For details, refer to "Using the PC Assistant (P50)" in the *DJI Matrice 100 User Manual*.

Method 2 – Using the DJI N1 Video Encoder

Download the firmware update package. For details, refer to the *N1 Video Encoder User Manual*.
(<http://www.dji.com/product/matrice100/info#downloads>)



- Remove the propellers before upgrading the firmware to prevent injuries.
 - DO NOT start the motors or touch the motors when upgrading.
 - The remote controller may become unlinked from the aircraft after upgrading the firmware. Re-link if necessary.
 - It is normal for the aircraft to make sounds or flash its LEDs when upgrading to indicate the upgrade status.
 - Your Micro SD card should only contain one firmware update package.
 - Storage devices must be formatted with the FAT32 or exFAT file system.
-

Upgrading the Remote Controller Firmware

The System Status bar in the DJI GO app (center top of the camera view screen) will flash several times if a firmware upgrade is available.

Step 1- Check your devices

Make sure:

- Remote controller has at least a 50% charge..
- Mobile device is connected to the internet.
- Mobile device has 30 MB of free space.

Step 2- Run the upgrade

1. Launch DJI GO and tap through "Camera View > System Status Bar > Overall Status".
2. Tap "Download Firmware" to download the package and upgrade the firmware.

If the firmware upgrade fails, check the connection between the remote controller and your mobile device, and then try again. Contact DJI Support if the problem persists.

(<http://www.dji.com/support>)



- DO NOT perform firmware upgrades when the aircraft is airborne.
 - The remote controller may become unlinked from the aircraft after upgrading the firmware. Re-link if necessary.
 - Ensure that your internet connection is stable before downloading the package.
-

Component Dimensions

Use the dimensions below to help you customize your Matrice 100 platform (all units in mm).

Aircraft

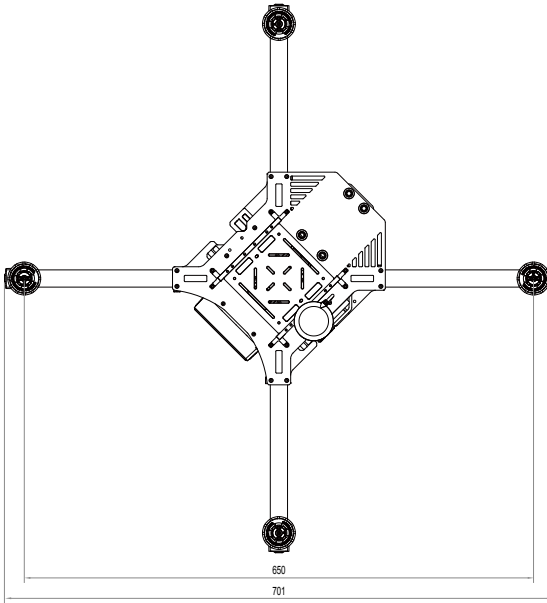
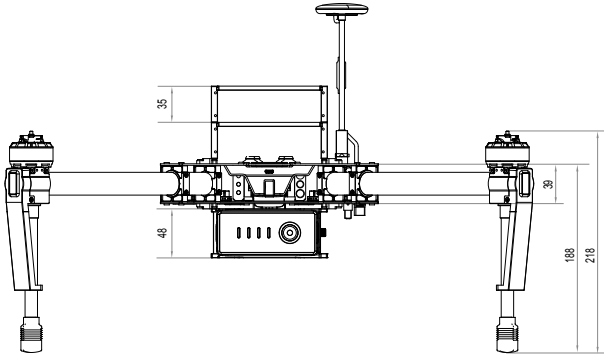

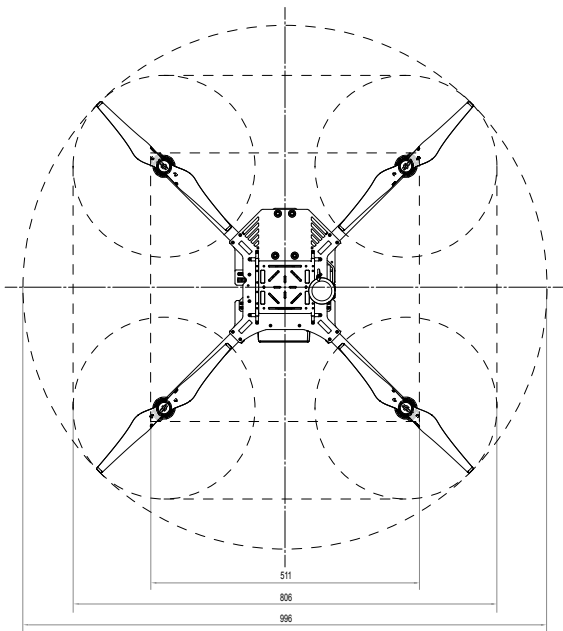

Remote Controller

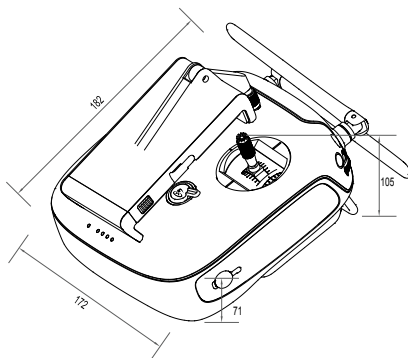

Gimbal Mounting Plate

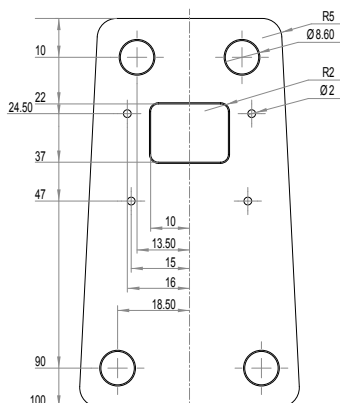

Battery Compartment

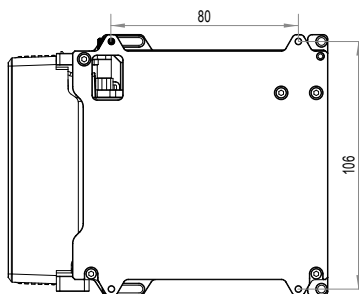

DJI Zenmuse X3 Gimbal and Camera

Camera

Camera Profile

The X3 gimbal camera can record up to 4K 4096x2160p video at 24 fps, and capture 12-megapixel images. It features a 1/2.3" Sony EXMOR CMOS image sensor. Preview of the camera's POV in the DJI GO app before shooting images and video. Have extra options to shoot stills in burst mode or self-timer mode, and export video in either MOV or MP4 format.

Camera Micro SD Card Slot

To store your photos and videos, plug in the Micro SD card into the Micro SD card slot on the gimbal before powering on the Matrice 100. The camera supports a single Micro SD card of up to 64GB. A UHS-1 type Micro SD card is recommended because of its fast read and write capability, allowing you to store high-resolution video files.

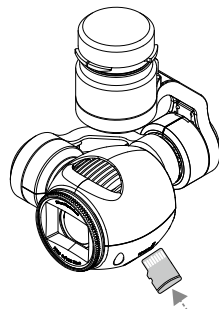

- ⊘ Do NOT remove the Micro SD card from the gimbal when it is powered on.

Camera Data Port

Power on the Matrice 100 and then connect a USB cable to the Camera Data Port to download photos or videos from the camera to your PC.



 Power on the aircraft before downloading the files.

Camera Operation

Use the Shutter and Record button on the remote controller to shoot images or the videos through the DJI GO app. For more information on how to use these buttons, refer to [Controlling the Camera \(P33\)](#).

ND Filter

Attach an ND filter to the front of the camera to reduce over exposure and the 'jello' effect.

Gimbal

Gimbal Profile

The 3-axis gimbal provides a steady platform for the camera, allowing you to capture stable video and images. The gimbal can tilt the camera up to 120 degrees and rotate 320 degrees.

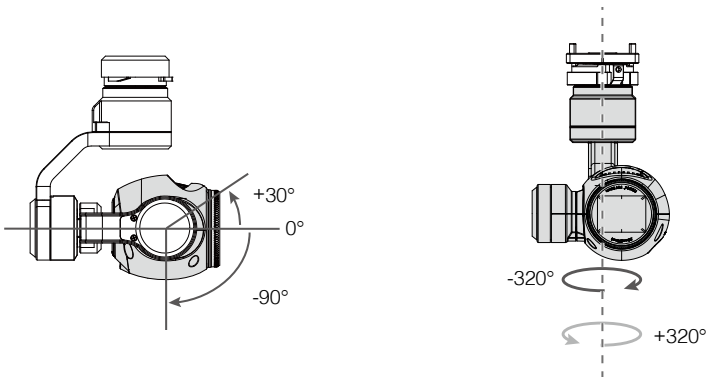

Under the default settings, turn the gimbal dial on the remote controller to tilt the camera. Note that you cannot simultaneously tilt and pan the camera in the Single Remote Controller mode. Enable the Master-and-Slave mode in the DJI GO app and set a second remote controller to Slave if you wish to tilt and pan the camera together.

Gimbal Dial Settings

Follow the instructions below to use the gimbal dial to tilt/pan the camera:

1. Power on the aircraft and the remote controller.
2. Go to the DJI GO app > Camera View > Tap  > Tap RC Control Settings.
3. Set the customizable button C1 or C2 as the Gimbal Pitch/Yaw.

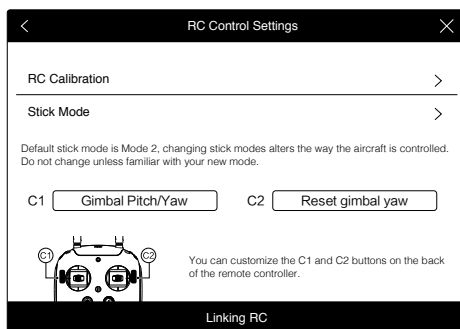

Press the C1 or C2 button to switch between pitch mode and yaw mode. Use the gimbal dial to control the tilt/pan motion of the camera.

Using the DJI GO App to Control the Gimbal

Follow the steps below to use the DJI GO app to control the gimbal's pitch/yaw motion:



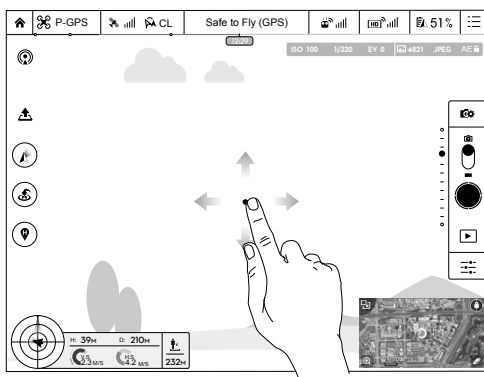



1. Go to the DJI GO app > Camera View.
2. Tap and hold on the screen until a blue circle appears.
3. Move your finger to control the gimbal's pitch/yaw motion.

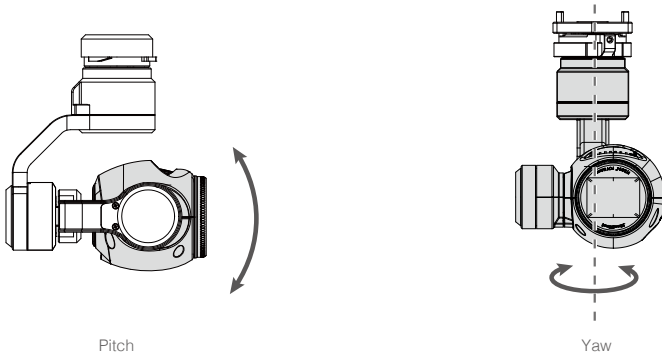

Gimbal Operation Modes

Switch between the three operation modes in Camera View in the DJI GO app. Note that your mobile device must be connected to the remote controller for changes to take effect. Refer to the table below for details:



	 Follow Mode	The gimbal's orientation is aligned with the aircraft's nose. One user alone can control the pitch motion of the gimbal, but a second operator is required to control the yaw motion using a second remote controller.
	 FPV Mode	The Gimbal will lock to the movement of the aircraft to provide a First-Person-View flying experience.
	 Free Mode	The Gimbal's motion is independent of the aircraft's orientation. One user alone can control the pitch motion of the gimbal, but a second user is required to control the yaw motion using a second remote controller.
	 Re-alignment	Re-align the yaw angle of the gimbal with that of the aircraft. The pitch angle remains unchanged during the re-alignment.
	<ul style="list-style-type: none"> • A gimbal motor error may occur if the gimbal is placed on an uneven ground because of impact with ground objects. Be sure to take off from a flat, open ground to protect the gimbal from impact. • Flying in heavy fog or inside clouds may make the gimbal wet, leading to a temporary failure. The gimbal will recover when it dries out. 	

Specifications

Gimbal	
Model	Zenmuse X3
Power Output (Camera Attached)	Static: 9 W; In Motion: 11 W
Operating Current	Static: 750 mA; In Motion: 900 mA
Angular Vibration	±0.03°
Mounting	Detachable
Controllable Range	Pitch: -90° to +30°; Yaw: ±320°
Mechanical Range	Pitch: -125° to +45°; Yaw: ±330°
Controllable Speed	Pitch: 120°/s; Yaw: 180°/s
Camera	
Name	X3
Model	FC350
Total Pixels	12.76 M
Effective Pixels	12.4 M
Max Image Size	4000 x 3000
ISO	100-3200 (Video); 100-1600 (Photo)
Shutter	8 to 1/8000 s
FOV (Field Of View)	94°
CMOS	Sony EXMOR 1/2.3"
Lens	20 mm (35 mm format equivalent), f/2.8 9 elements in 9 groups Anti-distortion
Still Photography Modes	Single shot Burst mode: 3/5/7 frames Auto Exposure Bracketing (AEB): 3/5 frames at ±0.7EV Timed shot
Video Recording Modes	UHD (4K): 4096x2160p 24/25, 3840x2160p 24/25/30 FHD: 1920x1080p 24/25/30/48/50/60 HD: 1280x720p 24/25/30/48/50/60
Video Storage Bitrate	60 Mbps
Supported File Formats	FAT32/exFAT Image: JPEG, DNG Video: MP4/MOV (MPEG-4 AVC/H.264)
Supported SD Cards	Micro SD Max capacity: 64 GB; Class 10 or UHS-1 rating required
Operating Temperature	-10 to 40 °C

DJI N1 Video Encoder

The N1 Video Encoder is intended for the Matrice 100 and DJI N1 Flight Controller, for which it offers video signal transmission and firmware upgrade capabilities if you are not using the Zenmuse X3 Gimbal and Camera as your recording device.

The AV or HDMI port on the encoder receives video input from the non-DJI camera to generate a live HD video feed in the DJI GO app. In addition, users may utilise the Micro USB port on the encoder to upgrade the firmware of various modules on the Matrice 100.

Refer to the *N1 Video Encoder User Manual* for details.
(<http://www.dji.com/product/matrice100/info#downloads>)

DJI Guidance System Mounting Warning

1. If you mount the Guidance Sensors directly under the battery compartment, disconnect the cable of the rear facing Guidance Sensor before accessing the Intelligent Flight Battery.

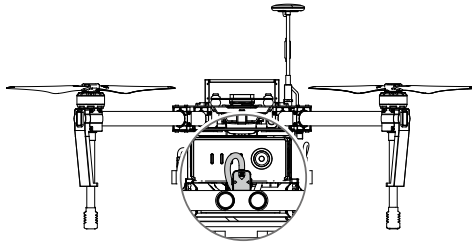

2. If you mount the side Guidance Sensors above the center frame, ensure they are mounted at least 8 cm (by stacking three expansion bays or one battery compartment with two expansion bays) above the center frame, so that the propellers will not obstruct them. Be sure to mount the down facing Guidance Sensor under the aircraft. Finally, mount the GPS mount on top of the expansion bay using two M3x8 screws.

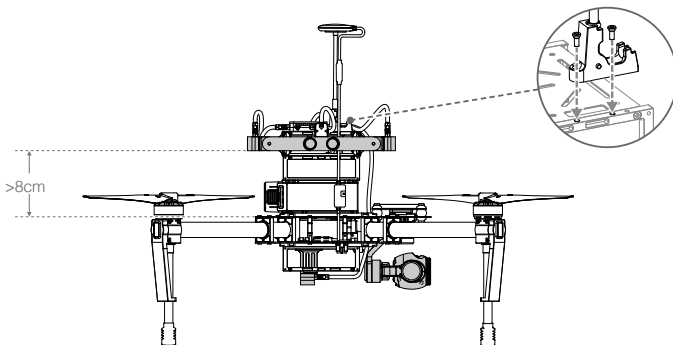

3. If you are using the DJI Zenmuse X3 Gimbal and Camera and the DJI Guidance system together, be sure to mount the side Guidance Sensors above the center frame, otherwise you will be unable to mount the front facing Guidance Sensor.

Compliance Information

FCC Warning Message

Any Changes or modifications not expressly approved by the party responsible for compliance could void the user's authority to operate the equipment.

This device complies with part 15 of the FCC Rules. Operation is subject to the following two conditions: (1) This device may not cause harmful interference, and (2) this device must accept any interference received, including interference that may cause undesired operation.

FCC Radiation Exposure Statement:

This equipment complies with FCC radiation exposure limits set forth for an uncontrolled environment. This equipment should be installed and operated with minimum distance 20cm between the radiator & your body. This transmitter must not be co-located or operating in conjunction with any other antenna or transmitter.

Note: This equipment has been tested and found to comply with the limits for a Class B digital device, pursuant to part 15 of the FCC Rules. These limits are designed to provide reasonable protection against harmful interference in a residential installation. This equipment generates uses and can radiate radio frequency energy and, if not installed and used in accordance with the instructions, may cause harmful interference to radio communications. However, there is no guarantee that interference will not occur in a particular installation. If this equipment does cause harmful interference to radio or television reception, which can be determined by turning the equipment off and on, the user is encouraged to try to correct the interference by one or more of the following measures:

- Reorient or relocate the receiving antenna.
- Increase the separation between the equipment and receiver.
- Connect the equipment into an outlet on a circuit different from that to which the receiver is connected.
- Consult the dealer or an experienced radio/TV technician for help.

IC RSS Warning

This device complies with Industry Canada licence-exempt RSS standard (s). Operation is subject to the following two conditions: (1) this device may not cause interference, and (2) this device must accept any interference, including interference that may cause undesired operation of the device.

Le présent appareil est conforme aux CNR d'Industrie Canada applicables aux appareils radio exempts de licence.

L'exploitation est autorisée aux deux conditions suivantes:

- (1) l'appareil ne doit pas produire de brouillage, et
- (2) l'utilisateur de l'appareil doit accepter tout brouillage radioélectrique subi, même si le brouillage est susceptible d'en compromettre le fonctionnement.

IC Radiation Exposure Statement:

This equipment complies with IC RF radiation exposure limits set forth for an uncontrolled environment. This transmitter must not be co-located or operating in conjunction with any other antenna or transmitter.

This equipment should be installed and operated with minimum distance 20cm between the radiator & your body.

Any Changes or modifications not expressly approved by the party responsible for compliance could void the user's authority to operate the equipment.

KCC Warning Message

“해당무선설비는 운용 중 전파혼신 가능성이 있으므로 인명안전과 관련된 서비스는 할 수 없습니다.”

“해당 무선설비는 운용 중 전파혼신 가능성이 있음”



인증받은자의 상호 : SZ DJI TECHNOLOGY CO., LTD

제품명 / 모델명 : 특정소출력무선기기 (무선데이터통신시스템용무선기기)/M100

제조사 및 제조국가 : SZ DJI TECHNOLOGY CO., LTD

제조년월 : 2016.05

인증번호 : MSIP-CRM-dji-TP1406

해당 무선설비는 전파혼신 가능 성이 있으므로 인명안전과 관련된 서비스는 할 수 없음

NCC Warning Message

Administrative Regulations on Low Power Radio Waves Radiated Devices warning:

Article 12

Without permission granted by the NCC, any company, enterprise, or user is not allowed to change frequency, enhance transmitting power or alter original characteristic as well as performance to an approved low power radio-frequency devices.

Article 14

The low power radio-frequency devices shall not influence aircraft security and interfere legal communications; If found, the user shall cease operating immediately until no interference is achieved. The said legal communications means radio communications is operated in compliance with the Telecommunications Act.

The low power radio-frequency devices must be susceptible with the interference from legal communications or ISM radio wave radiated devices.

This content is subject to change.

Download the latest version from
<http://www.dji.com/product/matrice100>

If you have any questions about this document, please contact DJI by sending a message to DocSupport@dji.com.

© 2016 DJI. All Rights Reserved.

